

# Link Training Systems by SINGER

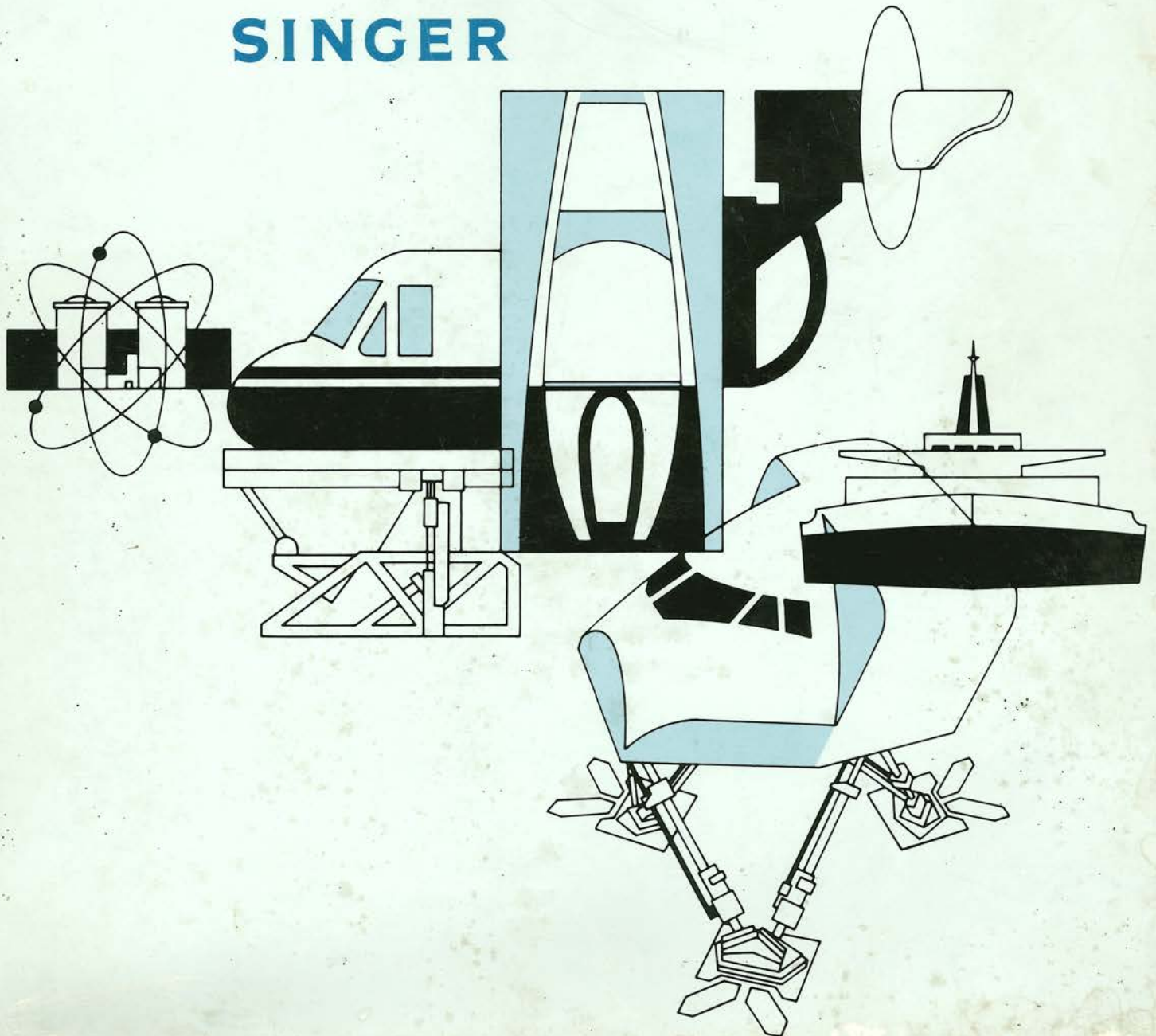

November 1973  
Printed in U.S.A.

# LINK Training Systems

**Simulation Products Division  
The Singer Company  
Binghamton, New York**



# Introduction

Although the corporate name has been changed, The Singer Company's Simulation Products Division has been the developer and manufacturer of LINK\* trainers since 1929. Today, the Division is the foremost producer of simulation and training products with four plant complexes, an international reputation, and an annual business in excess of \$100 million. Its flight simulator customers alone include almost every major U.S. and international airline, all branches of the U.S. Military, and the defense arms of numerous other governments including Great Britain, Sweden, Iran, and Germany. While aircraft flight simulators comprise the bulk of the business, the product line has expanded in scope and variety to a broad spectrum of training devices and services:

- **COMMERCIAL FLIGHT SIMULATORS**
- **MILITARY TRAINERS**
  - FLIGHT AND WEAPON SYSTEMS TRAINERS**
  - VTOL SIMULATORS**
  - ASW TRAINERS**
  - HELICOPTER TRAINERS**
  - TANK TRAINERS**
- **RESEARCH SIMULATORS**
- **SPACE SIMULATORS**
- **MARITIME TRAINING SYSTEMS**
- **GENERAL AVIATION TRAINERS**
- **SIMULATION SYSTEMS AND TECHNIQUES**
  - DIGITAL COMPUTERS**
  - MOTION SYSTEMS**
  - VISUAL SYSTEMS**
  - RADAR LANDMASS SYSTEMS**
  - TRAINING SYSTEMS**
- **INDUSTRIAL SIMULATORS**
- **TRAINING PROCEDURES AND DEVICES**
- **CLOSED-CIRCUIT TELEVISION SYSTEMS**
- **TRAFFIC CONTROL SYSTEMS**
- **CUSTOMER SUPPORT**
  - FIELD SERVICE**
  - TECHNICAL TRAINING**

---

\*Trademark of The Singer Company



**.. the first Link Trainer . . . 1929**

## **Worldwide Support**

Experienced Singer personnel, stationed in many countries, are available to install each system and to give instructions for its operation and maintenance. This worldwide organization also stands ready to provide both regular and emergency service and to furnish replacement parts. Singer also cooperates with customers in analyzing facilities and requirements in order to make recommendations for spares provisioning.

Each system is accompanied by comprehensive operating and maintenance instructions. These describe the hydraulic system, mechanical assemblies, computer complex, and instructional controls, and explain preoperational and preflight checks and turn-on and shutdown procedures.

# Simulation Products Division

Simulation Products Division is headquartered in Binghamton, New York, as is the Flight Simulation Operations. Silver Spring Operations, as the name implies, is located in Silver Spring, Maryland; Advanced Products Operations in Sunnyvale, California; and Link-Miles Ltd. is situated in Lancing, England. While each of the foregoing components specializes to a certain extent, as described herein, the fact that they are all concerned with training techniques and simulation products facilitates continuous cross-fertilization of concepts, reciprocal coordination and support by personnel, and exchange of techniques and systems, both hardware and software.

## ***Flight Simulation Operations***

Flight Simulation Operations (FSO), the largest of the product groups, designs, develops, and manufactures commercial flight simulators such as the B-747 and L-1011, military weapon system (flight and tactics) trainers such as the F-4 and F-111, and space simulators such as the Apollo Command and Lunar Modules and Skylab. In addition to these, FSO develops and fabricates a host of special-purpose simulation systems such as visual systems, motion systems, and radar landmass systems.

**Kirkwood Facility  
Binghamton**

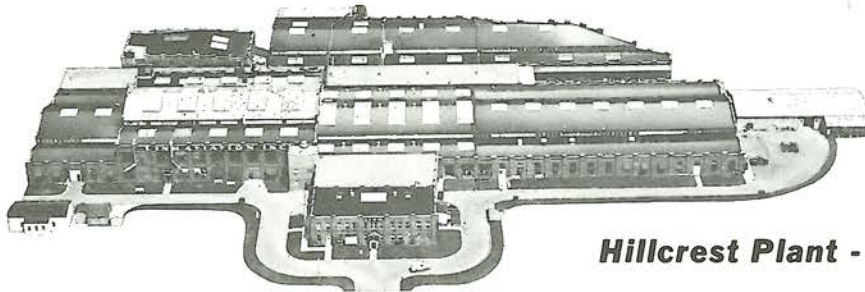
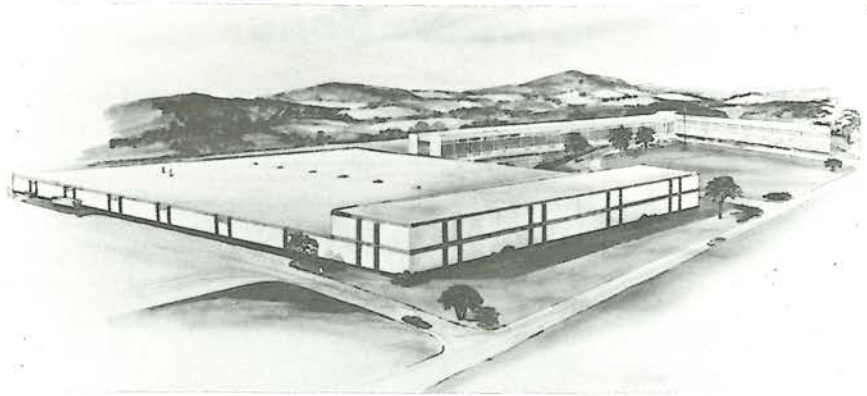

**Hillcrest Plant - Binghamton**

## **Advanced Products Operations**

Advanced Products Operations is the applied research and development arm of the Simulation Products Division, and originally developed many of the techniques and devices currently being used in Singer simulators today. For example, the Singer GP-4 and GP-4B digital simulation computers were initially developed at the Sunnyvale facility. A principal area of current advanced development is digital image generation for application to radar landmass and visual systems.



**APO - Sunnyvale, Cal.**



## Silver Spring Operations

Silver Spring Operations (SSO) specializes in design and manufacture of maritime simulators, anti-submarine warfare (ASW) trainers, and part-task and classroom training devices. SSO produced the Collision Avoidance Radar Simulator (CARS)



which is used at the Maritime Institute of Technology and Graduate Studies in Baltimore, Md., to train ship pilots; and the P3A, P3B, S2E, S2F-3, P2V-5, P2V-7 and, currently, the S-3A are exemplary of SSO-designed ASW trainers. While SSO has produced many classroom devices for training aircrews, it has also produced training devices for use in such industries as chemical, petrochemical, and wood pulp.

**Silver Spring Plant**  
**Silver Spring, Md.**

## Link-Miles Ltd.

Prior to becoming part of Singer in 1969, Link-Miles was Miles Electronics, Ltd., a developer and manufacturer of flight simulators for 12 years and a company with its roots deep in aviation and aircrew training for the past 40 years.

Because of its location, Link-Miles has concentrated primarily on the European and Asian markets for its commercial and military flight simulators. The Harrier Trainer, the world's first operational vertical takeoff and landing (VTOL) fighter aircraft simulator, was designed and built for the Royal Air Force by Link-Miles. Also, Link-Miles has produced DC-10 simulators for Alitalia, National and Northwest Orient Airlines.

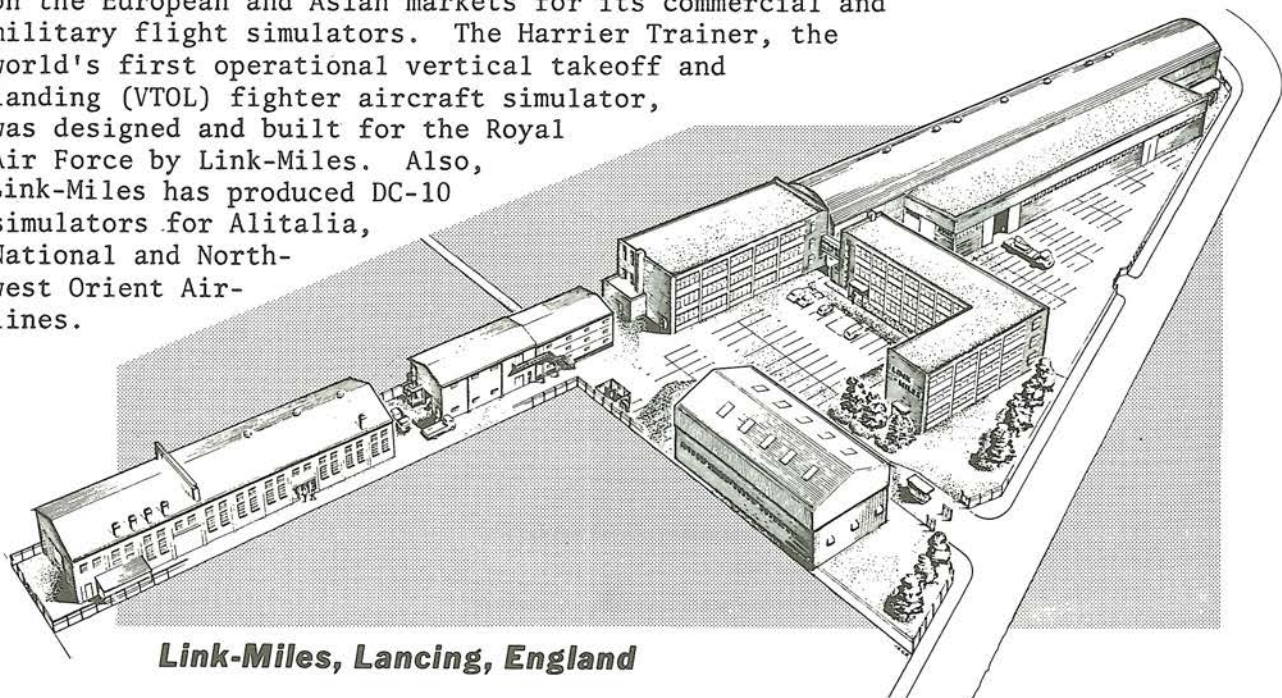

**Link-Miles, Lancing, England**

# Commercial Flight Simulators

Singer preeminence in the field of commercial simulation has been continuously reconfirmed as evidenced by such achievements as:

- First commercial jet transport simulator, the DC-8, in 1958
- First operational commercial digital flight simulator, the Boeing 727, in 1963
- First dual simulator installation utilizing a single digital computer, the Pan American Boeing 707/727 facility, in 1966
- First operational wide body jet transport simulator, the Boeing 747, installed in the TWA training facility in 1970

While these achievements attest to advancements in simulator state of the art, the fact that every LINK trainer is designed to meet or exceed FAA certification requirements indicates the quality that is inherent in every Singer simulator.

In the last seven years alone, the Simulation Products Division has delivered more than 50 full commercial simulators, 12 dual simulators, and countless part-task and classroom commercial training devices. The purchasers of these systems are well-known names in the field of commercial aviation:

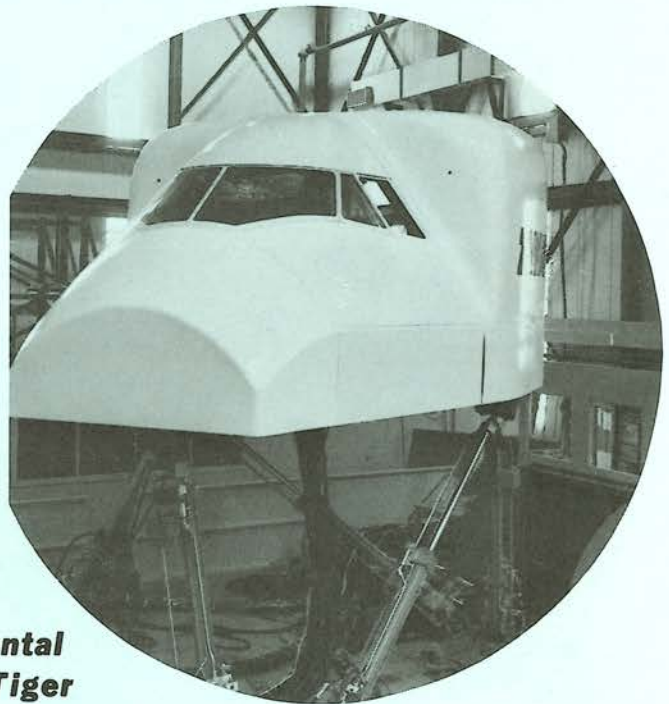

**Aer Lingus • Aeronaves  
Air France • Alitalia  
American • ATI • BEA  
BOAC • Braniff • Continental  
Delta • Eastern • Flying Tiger  
Lufthansa • Mexicana  
Mohawk • National • Iberia  
Northwest • Pan Am • PIA  
Qantas • Sabena • SAS  
S African • TWA • United**



***Commercial Simulators in test and assembly***

***Singer Simulators  
at airline training  
facilities . . .***



**Commercial Flight Simulators**

## DIGITAL SIMULATORS

<u>A/C TYPE</u>	<u>CUSTOMER</u>	<u>COMPUTER</u>	<u>DEL</u>	<u>QTY</u>
BAC-111	Mohawk	GP-4	1966	1
FH-227	Mohawk	GP-4	1966	1
DC-8	Aeromexico	GP-4	1968	1
	Alitalia	GP-4	1967	1
	Delta	GP-4	1969	1
	Eastern	GP-4	1967	1
	Flying Tiger	GP-4	1968	1
	SAS	GP-4	1967	1
	United	GP-4	1967	1
DC-9	Aeromexico	GP-4	1968	1
	Alitalia	GP-4	1967	1
	ATI	GP-4	1971	1
	Continental	GP-4	1966	1
	Delta	GP-4	1969	2
	Eastern	GP-4	1967	1
	SAS	GP-4	1967	1
	SAS	GP-4	1969	1
	TWA	GP-4	1966	1
707	Air France	GP-4	1970	1
	American	GP-4	1968	3
	American	GP-4	1969	1
	Boeing	GP-4	1967	1
	Northwesr	GP-4	1967	1
	Pan Am	GP-4	1966	2
	Pan Am	GP-4	1967	2
	PIA	GP-4	1969	1
	Qantas	Mark I	1965	1
	Qantas	GP-4	1969	1
	TWA	GP-4	1966	2
	TWA	GP-4	1968	1
720	Continental	GP-4	1966	1
727	Air France	GP-4	1967	1
	American	GP-4	1967	1
	American	GP-4	1968	1
	American	GP-4	1969	1
	Braniff	Mark I	1966	1
	Continental	GP-4	1968	1
	Delta	GP-4	1973	1
	Delta	GP-4	1974	1
	Eastern	Mark I	1968	1
	Iberia	PDP-11	1973	1
	Lufthansa	PDP-11	1973	1
	Mexicana	GP-4	1971	1
	National	GP-4	1967	1
	Northwest	GP-4	1967	1
	Pan Am	GP-4	1967	2
	Sabena	GP-4	1967	1
	TWA	Mark I	1964	1
	TWA	GP-4	1966	1
	TWA	GP-4	1969	1
	United	Mark I	1965	1
	United	Mark I	1966	1
	United	GP-4	1967	2
747	Air France	GP-4B	1975	1
	American	Sigma 5	1969	1
	Northwest	Sigma 5	1970	1
	TWA	Sigma 5	1969	1
	United	Sigma 5	1969	1
	Pan Am	GP-4B	1971	1
	Qantas	GP-4B	1970	1
	S. African	Sigma 5	1970	1
L-1011	Delta	GP-4B	1971	1
	Eastern	GP-4B	1971	1
	TWA	GP-4B	1971	2
DC-10	National	GP-4B	1972	1
	Northwest	GP-4B	1972	1
	Alitalia	GP-4B	1972	1
	SAS	GP-4B	1975	1

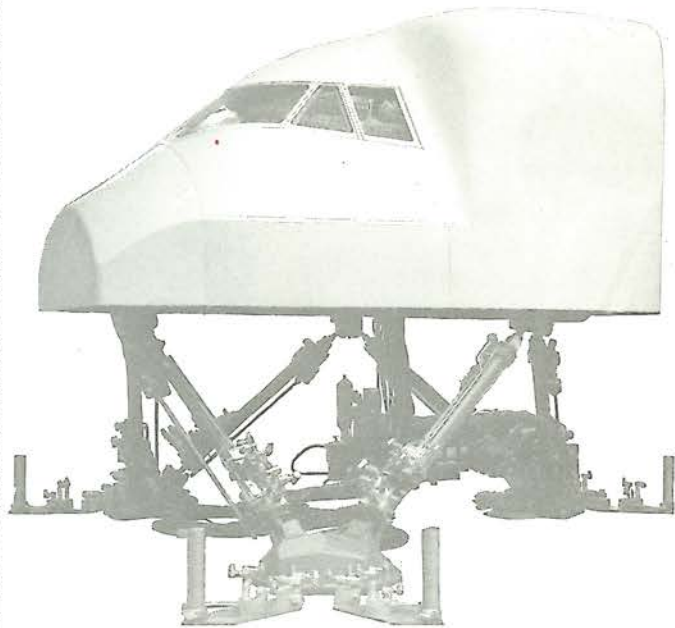

**747 Simulator . . . .**

## **History of Commercial Digital Flight Simulator Orders**

# Military Trainers

Today's military weapon system trainers (WST's) are highly sophisticated simulation devices capable not only of duplicating the flight environment of high-performance jet fighters and bombers but of reproducing the radar, electronic countermeasures, and weapon firing and delivery systems responses as well. The modern WST depends upon a digital computer complex to provide the pilot, and weapon operator, as applicable, with flight and tactical situations closely resembling those confronted in actual combat. The digital computer is the heart of the trainer, and interfaces with the pilot cockpit, instructor station, motion system, radar landmass systems, radar homing and warning system, and the various missile and weapon delivery systems.

The Singer-Simulation Products Division full military trainer product line covers a broad spectrum of vehicles: fighter aircraft such as the F-4 and Swedish AJ-37; antisubmarine warfare aircraft such as the P-3C and the Breguet 1150; training aircraft such as the T-2C and T-38; helicopters such as the UH-1H and the CH-47C; and tanks such as the British Chieftain.

While the sections herein describe only a representative few LINK trainers, the full range of Singer experience in developing military trainers is best exemplified by the following list of military aircraft, each of which has been simulated in one or more LINK trainers:

A-3D	F9F6	F-101B
A-3J	F-86D	Jaguar
A-5A	F-86L	Buccaneer
A-7A	F-89	Sea Vixen
AD-5N	F-102	RA-5C
AJ-37	F-104A	RB-66
B-47	F-105D	S2F1
B-57B	F-111E	S2F3
B-58	F-106	S2E
F4D-1	C-130B	P-3C
F-4C	C-130E	P2V5
F-4D	C-130H	P2V7
F-4E	C-135B	C-130K
F-4F	C-141A	P-5M
F-4J	KC-130F	P-3A
F-8C	KC-135A	T-2C
F-8E	RF-4C	T-39
F-8U	RF-4E	T-28B
F9F2	F-111A	T-37
F9F5	FB-111	J-35
Breguet 1150	F-111C	Harner
		T-38
		UH-1H
		CH-47C

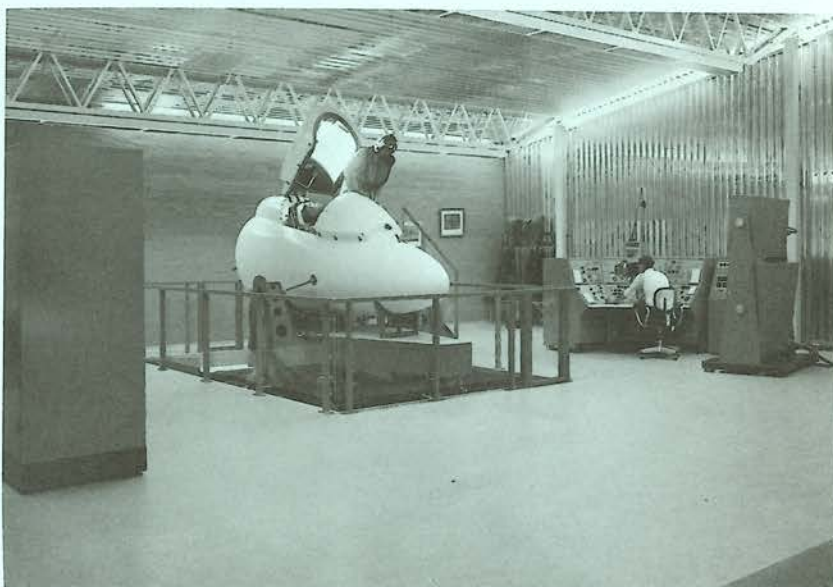

**Swedish Air Force  
J-35 Installation**

## **F-4 Series Weapon System Trainers**

In 1974, the Simulation Products Division will deliver an F-4E to the Turkish Air Force, and the first of four F-4E's to the Iranian Government, and it will deliver the 5th F-4F WST for the German Air Force in 1975. This will bring the total F-4 family of trainers produced to 60; previous orders have included seven RF-4C's, seven F-4C's, fifteen F-4D's, seventeen F-4E's, two RF-4E's, and two F-4J's. These flight and weapon system trainers all include a motion system, digital computer complex, trainee cockpit, and instructor station, and the majority also incorporate a radar landmass system, radar homing and warning system, and various missile and weapon delivery systems. It is particularly significant to note that the German F-4F trainers include the new SPD digital radar landmass system.

### **F-4D WST**

The tactics simulation of the AN/APQ-109 radar for the F-4D WST provides:

- Radar Simulation - Air-to-air, ground mapping (land-mass), fix-taking, and air-to-ground ranging
- Target Position Generator - Means for generating a single target, and a formation of four targets
- Chaff - Provisions for generating 12 chaff bundles, forward fired, and continuous chaff
- ECM Jamming - Barrage, sweep, sync wave, pulse, noise, range deception, angle deception, and multiple target jamming
- Decoy Drone - Active and passive decoy drone
- Anti-Jamming - Anti-jamming capabilities of the AN/APQ-100 radar
- Radar Source Audio and Steering - Radar homing missiles delivered by the F-4D.





**the F-4 Instructor Station**

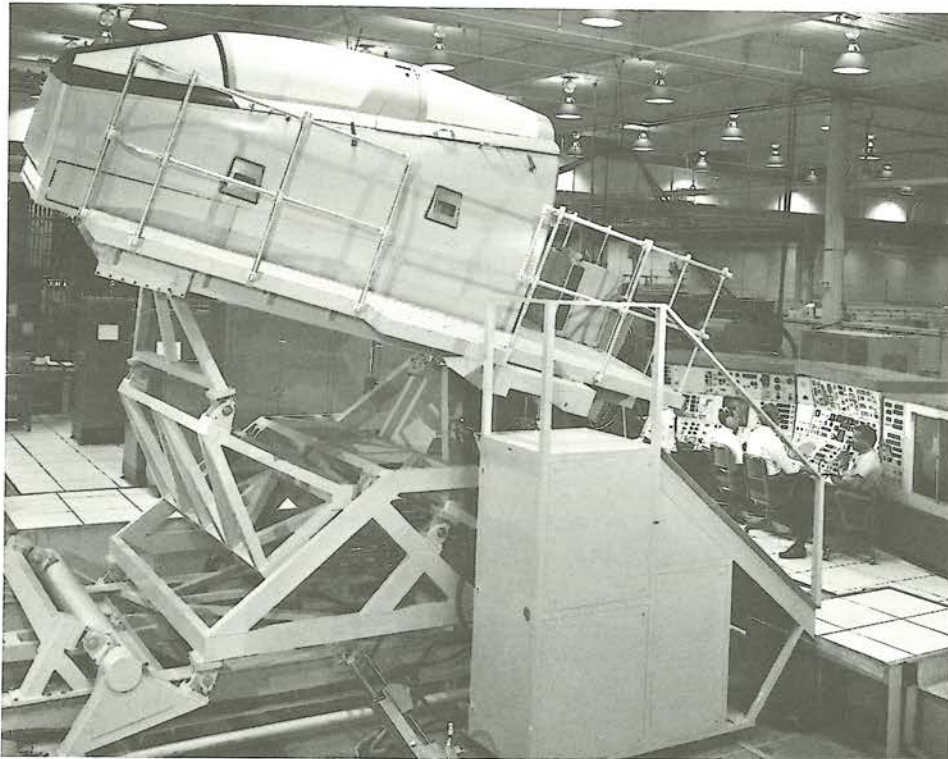
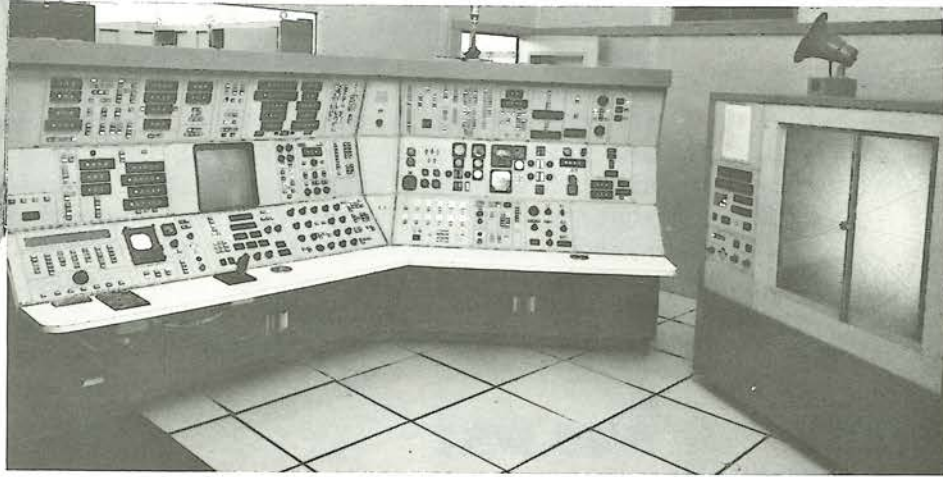

**F-4 during acceptance test**

Military Trainers

## **F-4E WST**

The F-4E WST, which is basically an updated version of the D model, incorporates an improved engine, the Vulcan cannon, AN/APQ-120 radar, and an improved fire control system. Because of the coherent-on-received doppler system (CORDS) tube installed for overland clutter rejection, the basic facility complement of the F-4D was increased to include:

- A single ground-maneuverable target
- A train/convoy of up to eight vehicles
- A fixed-ground jammer capable of emitting all swept and barrage types of emissions.

As frequently occurs, the F-4E WST was produced concurrent with the aircraft, and Singer designed the system to an interim AN/APQ-109 configuration to allow for minimum cost impact and equipment downtime upon retrofit. A complete digital range and angle track system, for example, was installed. Also, the digital peripheral conversion hardware was designed to meet the requirements of both systems, thus limiting the conversion effort in this area principally to program updating.

Other facilities incorporated for the F-4E were:

- An electronically-produced Walleye target for the systems TV mode of operations
- Ground and air beacon facilities capable of multiple code changes to provide training against a forward ground fire controller, as well as rendezvous operations associated with refueling
- A digitally interfaced situation display indicator (SDI) which, in a submode of operation, provides target and aircraft vector track history during the critical post-acquisition to weapons fire interval
- Hard-copy teletypewriter scoring printouts for post-mission critique and evaluation
- A completely computer-controlled evasive target, capable of various levels of ECM complexity, relieving the instructor of the task of manually controlling the problem, and thus allowing him more time to closely monitor the student.
- RHAWS

It is particularly significant to note that the F-4E WST, which includes the Simulation Products Division's Digital Target Generator and an improved landmass system, successfully demonstrated the soundness of the design philosophy by completing a 96-hour reliability run for the customer without incurring a single failure.

## **F-111 Series WST's**

A major military weapon system trainer (WST) accomplishment by the Simulation Products Division was the design and manufacture of F-111 simulators for the Air Force. To date, General Dynamics, manufacturer of the aircraft, has awarded Singer contracts for a total of 19 WST's: four F-111A's, one F-111C, one F-111E, five FB-111 Mission Simulators, 2FB-111 Bomb/Navigator Simulators, five F-111D's, and one F-111F.



***F-111 WST in assembly***

The tactics simulation provides for an integrated air-to-air and air-to-ground training capability in all phases of the radar and armament systems. The major facilities provided are radar landmass simulation, air target generation, jamming and chaff generation, GAR-8, GAM-83, and Shrike Missile simulation, as well as conventional and nuclear weapons. These facilities enable very comprehensive interceptor-bomber training.

### **F-111A**

The F-111A, one of the most sophisticated and comprehensive training devices ever developed by a simulator manufacturer, is representative of the entire F-111 family of trainers developed by Singer. The F-111A has a Singer-developed GP-4 digital computer complex, is designed to accomplish the total ground-based training curriculum, and is used for systems, procedural, and complete mission training.

The following target generation capabilities are available on the F-111A:

- Target Position Generation
  - Six air targets with expansion capability to 12
  - Ten ground targets
- ECM Simulation
  - Twelve chaff bundles plus one forward fired and one continuous type
  - Sixteen jammers simulate barrage sweep, sync wave, pulse, noise, CW, range deception and multiple target jamming
  - One decoy drone, active or passive
- Situation Display Indicator - 17-inch rectangular CRT is provided for the instructor to monitor the tactical situation. Alphanumerics are generated and displayed representing the aircraft, targets, drone, and chaff, giving the instructor a relative picture of the problem.
- Radar Simulation - Air-to-air, ground mapping (landmass), fix-taking, terrain following, and terrain avoidance capabilities are all incorporated.

The following aircraft tactical systems are fully and realistically simulated:

- Attack Radar AN/APQ-113 for search, detection, and acquisition of air and ground targets
- TFR/TAR AN/APQ-110 for terrain following and terrain avoidance capability
- Radar Homing and Warning Set AN/APS-109 for warning and homing capability when the aircraft is being illuminated by other radars
- Countermeasures Receiver Set AN/ALR-23, a rear hemisphere detection system for detecting missiles and targets passively
- Countermeasures Dispenser Set AN/ALE-31, a countermeasure system for manually or automatically dispensing ECM disposables as cues by the CMRS and RHAWS
- Lead Computing Optical Sight Set SU29/ASG-23 for computing the lead angle to a target from optical sight data
- Armament System for selecting and programming air-to-air and air-to-ground missiles, rockets, and bombs (conventional and nuclear) for the desired release and delivery.

## AJ-37 WST

Immediately following receipt of their second J-35 trainer, the Swedish Government contracted for two AJ-37 trainers to simulate the SAAB Viggen, which is a single seat, single engine, all weather, multi-

mission combat aircraft with secondary interceptor capability. Before the first two were completed, they ordered a third.

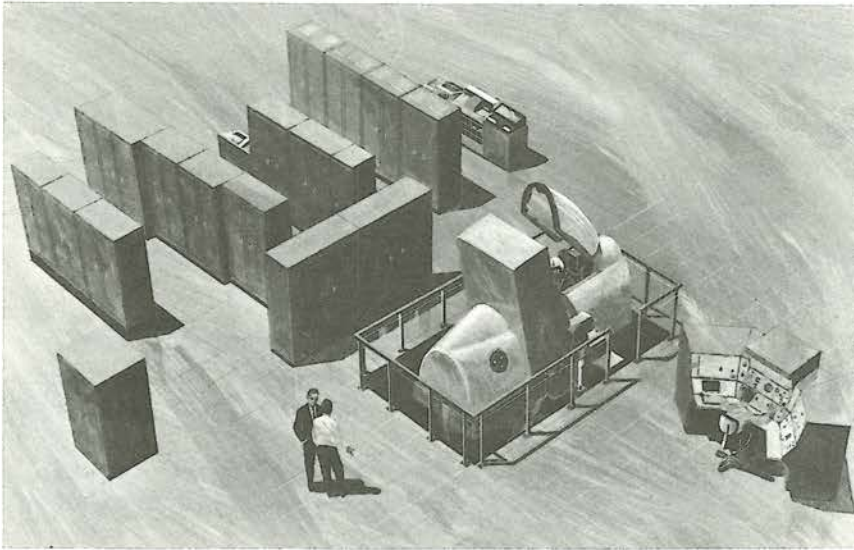

**Artist's conception  
of AJ-37 WST**

The AJ-37 Trainer is used by the Swedish Air Force for instruction of pilots in the procedures and techniques of flying the aircraft. The simulator facilitates training pilots in operational use of all controls and instruments during execution of ground operation, takeoff, landing, normal flight, various tactical maneuvers, navigation problems, tactical problems in weapons delivery and electronic countermeasure procedures, instrument approach procedures, and emergency conditions. The main elements of the simulator include:

- Three-degree-of-freedom motion system
- Analog radar landmass system
- Simplified visual system — black and white video display, 50° field of view virtual image, symbolic horizon, and symbolically generated target that varies in size with range
- GP-4B computer
- Singer-built linkage
- Display Unit — a CRT display unit and keyboard to enable the instructor to communicate with the computation system as well as depict and monitor cross-country, approach/landing, takeoff, and tactical procedures and situations
- Target Jamming Generator

## **P-3C Flight Trainers**

The Simulation Products Division was contracted by the Naval Training Equipment Center under Contract N61339-73-C-0106 to design and fabricate two P-3C Operation Flight Trainers, Device 2F87(F), and integrate them with previously delivered and operational P-3C Tactics Trainers, Device 2F87(T). The tactics trainers were designed and delivered by SPD's Silver Spring Operations, and are described elsewhere herein under ASW Trainers.

The principal elements of the Device 2F87(F) are:

- Trainee Station - An exact replica of the pilot, copilot, and flight engineer stations in the P-3C cockpit.
- Instructor Station - A cockpit-located control and monitoring system featuring a Sanders ADDS/500 display system, which provides two interactive CRT's, and a keyboard and functionally arranged controls to provide full instructor visibility and control of student training.
- Motion System - The Singer synergistic six-degree-of-freedom motion system.
- Computer Complex - Two PDP-11/45 central processing units with associated core and disc memory and peripheral equipment, including an ASR-35 teletypewriter, line printer, and paper tape reader and punch.
- Interface System - Interface equipment to permit both integrated and independent operation of the flight and tactics trainers and to link the flight trainer with a visual system.
- Poly-Voice\* Sound System - Unique Singer design for synthesis of aural cues under computer control.
- Advanced Training Program - Features Record/Playback and Evaluation modes.

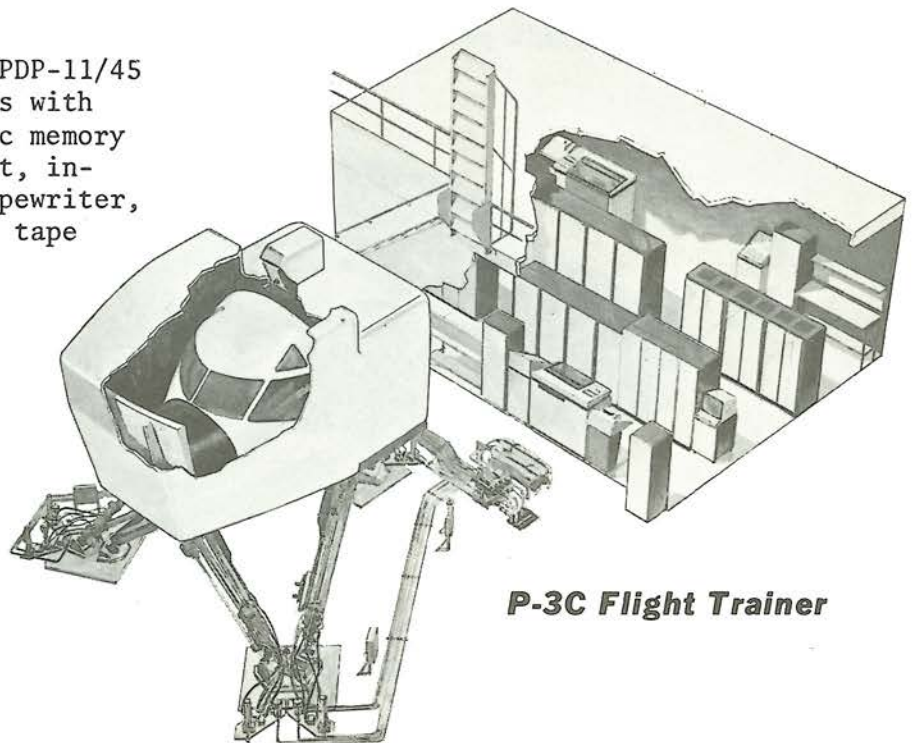

**P-3C Flight Trainer**

\*Trademark of The Singer Company

## **BREGUET 1150 Weapon System Trainer**

When the North Atlantic Treaty Organization (NATO) required simulators for the Breguet 1150 Atlantic twin-turboprop aircraft, it selected Singer-SPD to produce them. The program was a truly international effort in which SPD had full management responsibility for directing a team of companies from five NATO countries, and integrating the final flight and tactics systems into an operational weapon system trainer. Three complete WST's were eventually delivered to NATO sites in France and Germany.

The Breguet 1150 *Atlantic* aircraft is used by NATO for submarine surveillance and antisubmarine warfare, and was designed for detection, identification, location, and destruction of enemy submarines. It carries a crew of 12 (plus a relief crew of 12 on long missions), and is equipped with a full range of highly sophisticated ASW equipment, including MAD, ECM, autolyucus, radar, and sonobuoys. Armament includes bombs, depth charges, rockets, air-to-surface missiles, and homing torpedoes. A doppler radar navigation system, with a gyro platform heading reference, is used in conjunction with an analog navigation computer. At its patrol speed of 169 knots, the Breguet 1150 has an endurance of 18 hours. A total of 87 aircraft have been produced for France, Germany, The Netherlands, and Italy.

The Breguet 1150 simulators provide pilots and crews of this aircraft with individual as well as integrated crew training in the operation of the aircraft and its associated antisubmarine warfare (ASW) systems. They provide individual task training for the pilot, copilot, two sonobuoy operators, tactical coordinator, navigator, radio operator, MAD/ECM/autolyucus operator, and radar operator, and team training for the entire crew. Simultaneous or independent operation of the flight and tactics portions is possible.

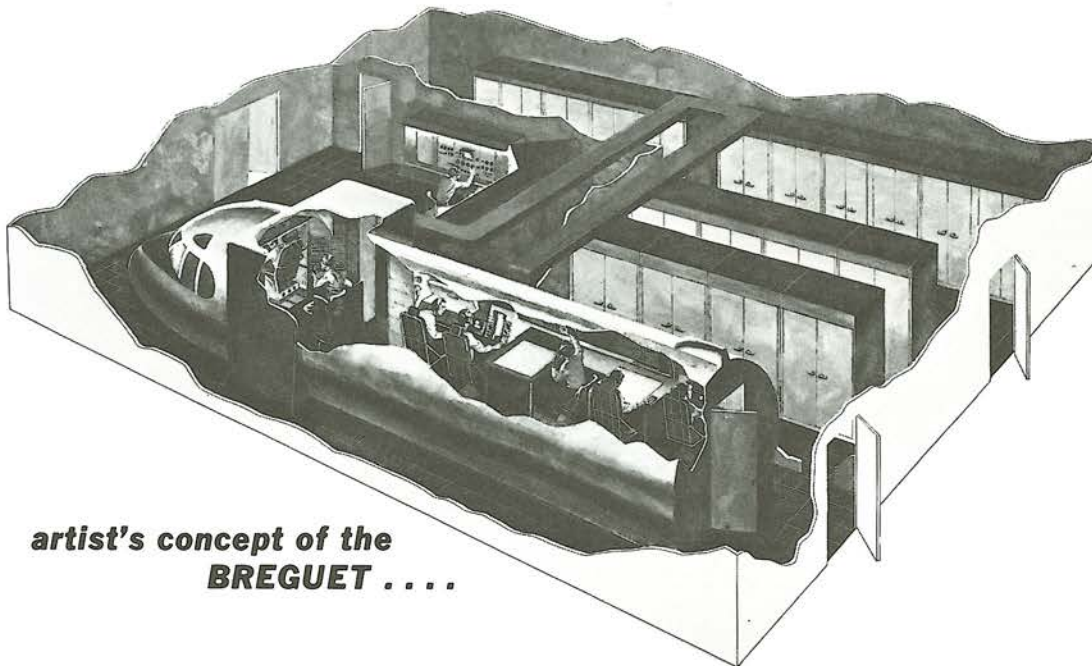

**artist's concept of the  
BREGUET . . . .**

## **Device 2F101, Four-Cockpit Training System**

The Simulation Products Division was awarded a contract by NTDC in March 1972 to develop and produce seven four-cockpit trainers to simulate the T-2C two-place, twin-jet engine, training aircraft. The 2F101 training system is a compact, low-cost trainer that enables complete, effective pilot training of four students, simultaneously and independently, in all shore-based, carrier-based, flight, emergency, and all-weather procedures. Each of the four-cockpit systems consists of only three major subassemblies:

- Trainee Station and Motion System - The trainee station has a simple fiberglass shell with a realistic interior in which all controls and instruments are fully simulated. The six-degree-of-freedom motion system is rugged and failsafe, and is the most advanced motion cue system in the simulation industry.
- Instructor Station - The station has three cathode-ray tubes in a single, compact, wrap-around unit that provides high quality vector and character display, and a display processor to make the system fully interactive and flexible.
- Electronics Cabinet - All electronics, including a DEC PDP-11 computer, are housed in a single double-bay cabinet.

The prototype Device 2F101 is scheduled for delivery to NTEC late in 1973, and the balance of six will be delivered at appropriate intervals with delivery of the last system in 1976.

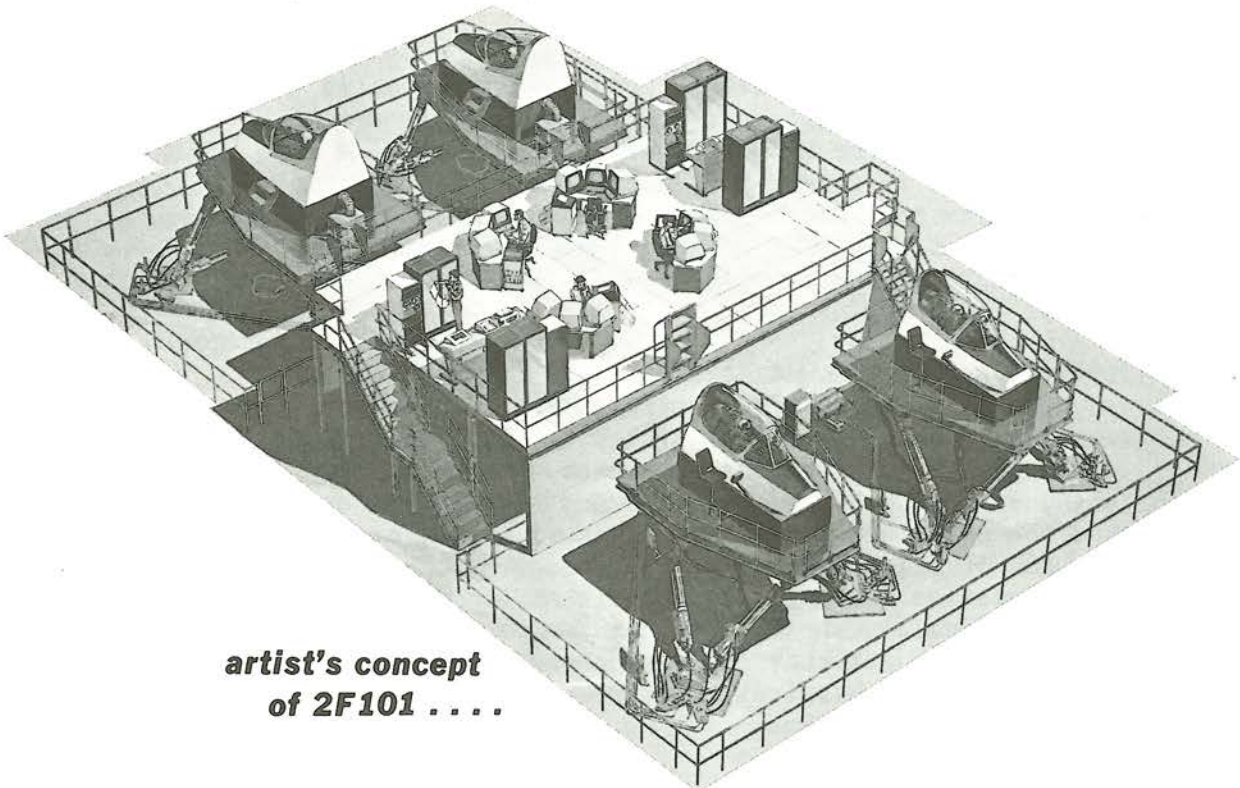

**artist's concept  
of 2F101 . . . .**



**Artist's concept of KC-130**

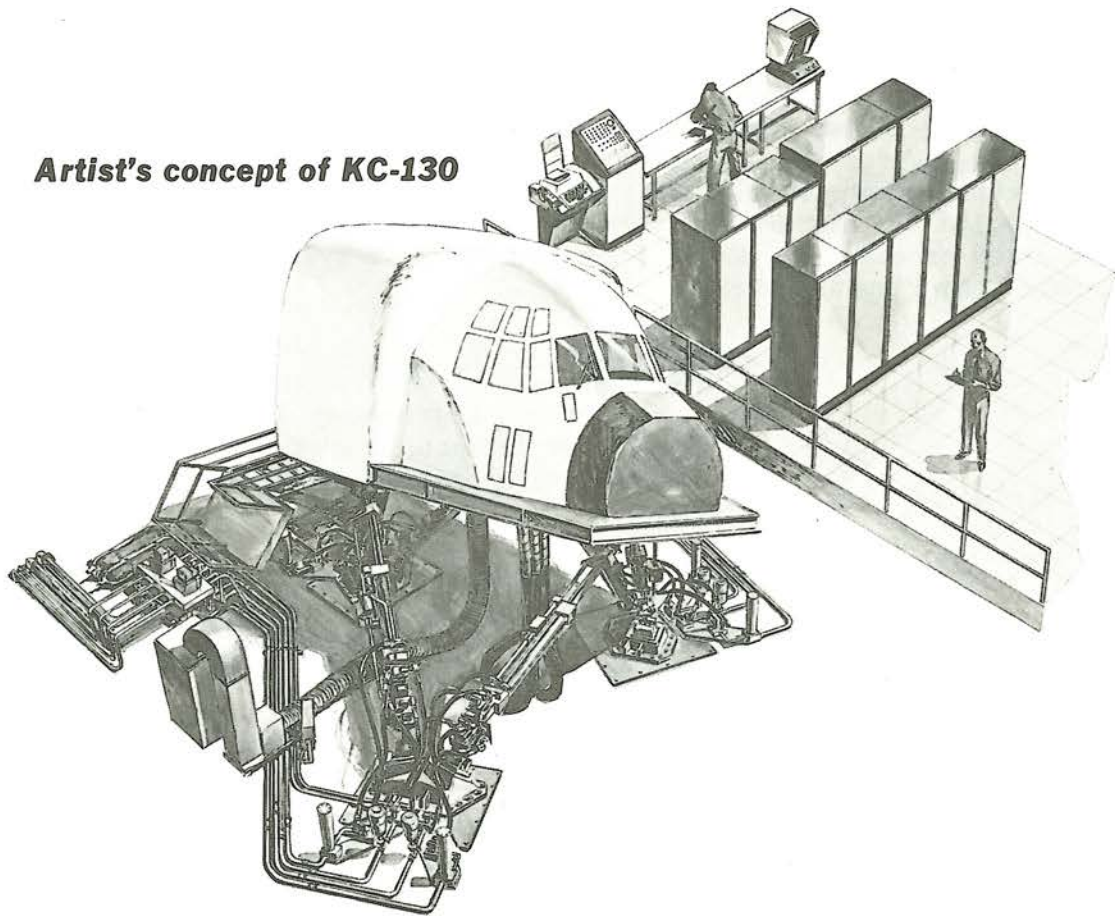

## **KC-130 OFT**

The prototype KC-130F trainer, Device 2F107, was contracted for by the Naval Training Equipment Center for the air arm of the U.S. Marine Corps. The 2F107 simulates the KC-130F, a four-turboprop-engine in-flight-refuel transport aircraft. The KC-130F features some of the same systems as the C-130H that was fabricated for Iran — trainee compartment interior and PDP-11/45 computer, for example — and other equipment used on earlier SPD programs.

The KC-130F trainee compartment is similar to the C-130H, internally, but has an added aft compartment to accommodate the instructor station. The motion system is the SPD-developed, standard six-degree-of-freedom motion system. The computer complex includes two PDP-11/45 central processing units, one with 32K and the other with 64K of core memory, a CRT and keyboard, an ASR-35 teletypewriter, and a paper tape unit. The instructor station features the Sanders ADDS/5000 CRT display system. Finally, the KC-130F has a number of advanced training features that include demonstration maneuvers, preprogrammed missions, checkrides, and trainee performance evaluation programs.

## Device 2F101, Four-Cockpit Training System

The Simulation Products Division was awarded a contract by NTDC in March 1972 to develop and produce seven four-cockpit trainers to simulate the T-2C two-place, twin-jet engine, training aircraft. The 2F101 training system is a compact, low-cost trainer that enables complete, effective pilot training of four students, simultaneously and independently, in all shore-based, carrier-based, flight, emergency, and all-weather procedures. Each of the four-cockpit systems consists of only three major subassemblies:

- Trainee Station and Motion System - The trainee station has a simple fiberglass shell with a realistic interior in which all controls and instruments are fully simulated. The six-degree-of-freedom motion system is rugged and failsafe, and is the most advanced motion cue system in the simulation industry.
- Instructor Station - The station has three cathode-ray tubes in a single, compact, wrap-around unit that provides high quality vector and character display, and a display processor to make the system fully interactive and flexible.
- Electronics Cabinet - All electronics, including a DEC PDP-11 computer, are housed in a single double-bay cabinet.

The prototype Device 2F101 is scheduled for delivery to NTEC late in 1973, and the balance of six will be delivered at appropriate intervals with delivery of the last system in 1976.

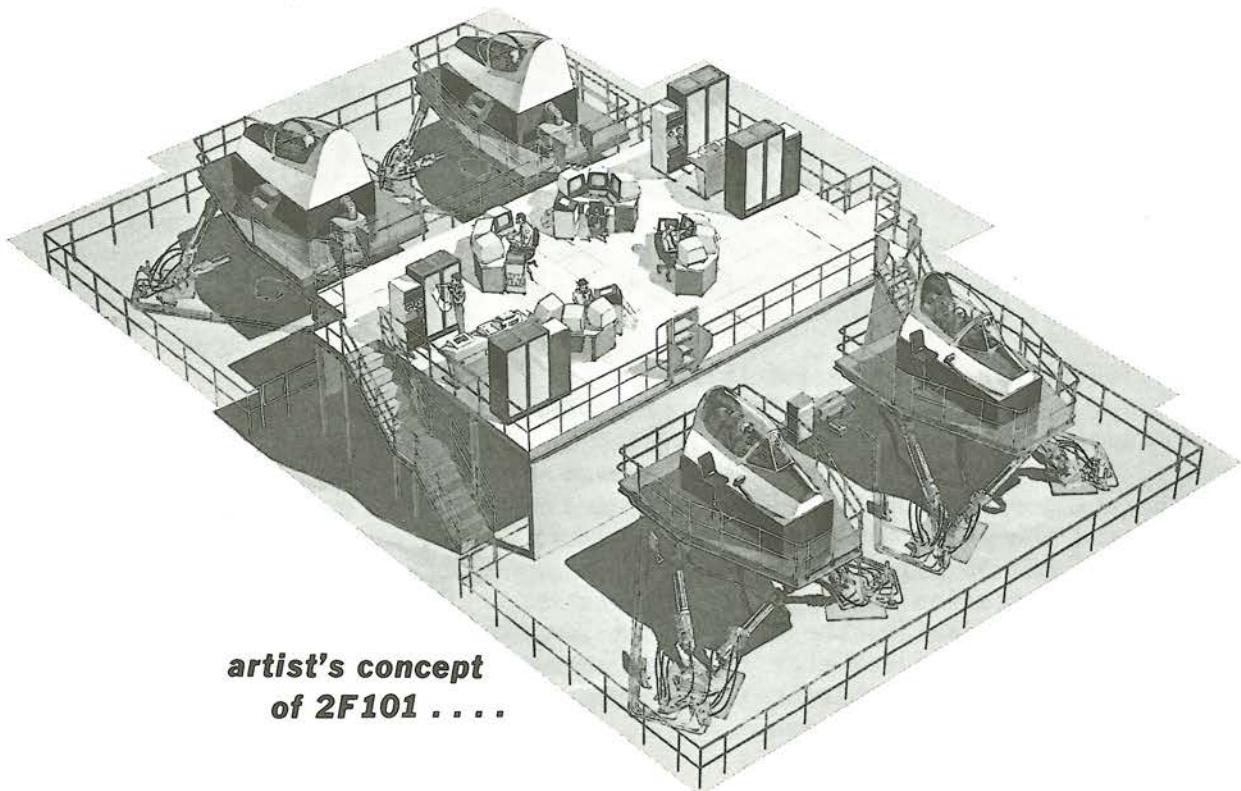

**artist's concept  
of 2F101 . . . .**

**Artist's concept of KC-130**

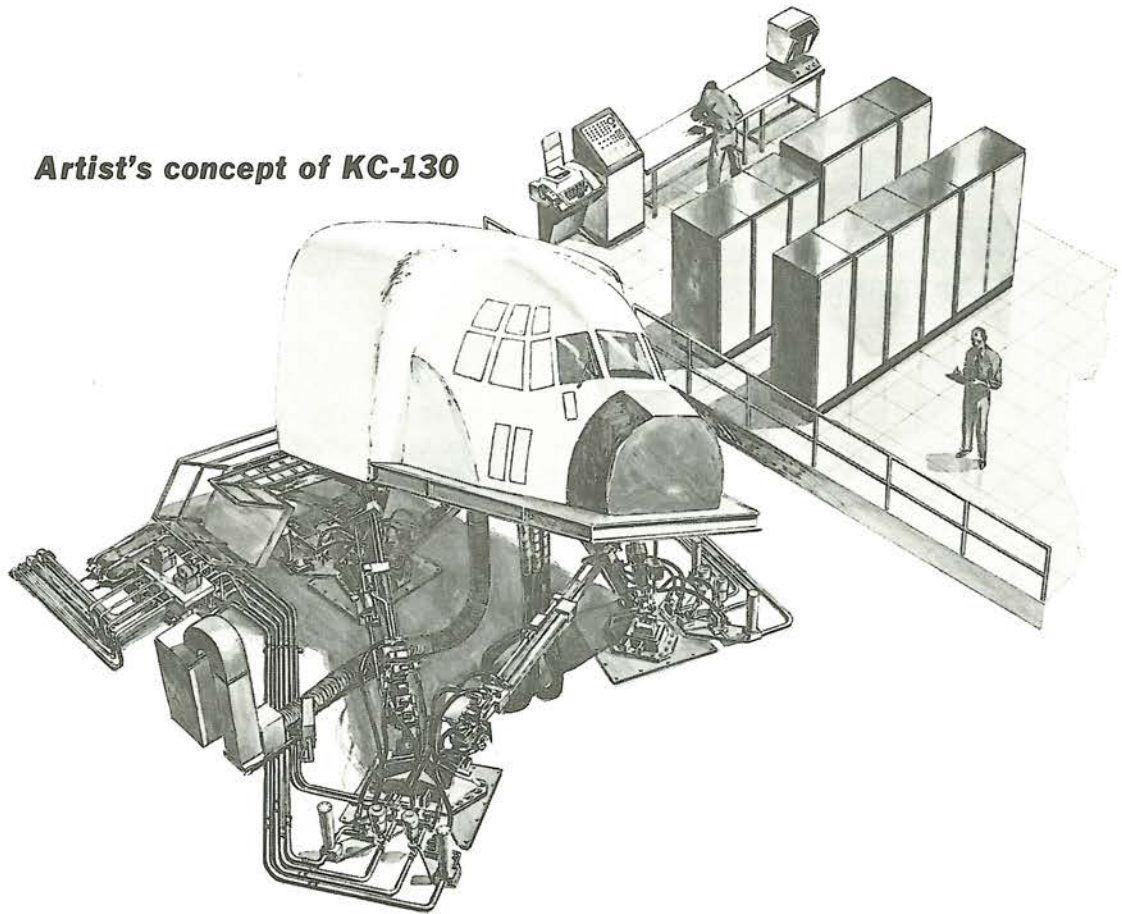

## **KC-130 OFT**

The prototype KC-130F trainer, Device 2F107, was contracted for by the Naval Training Equipment Center for the air arm of the U.S. Marine Corps. The 2F107 simulates the KC-130F, a four-turboprop-engine in-flight-refuel transport aircraft. The KC-130F features some of the same systems as the C-130H that was fabricated for Iran — trainee compartment interior and PDP-11/45 computer, for example — and other equipment used on earlier SPD programs.

The KC-130F trainee compartment is similar to the C-130H, internally, but has an added aft compartment to accommodate the instructor station. The motion system is the SPD-developed, standard six-degree-of-freedom motion system. The computer complex includes two PDP-11/45 central processing units, one with 32K and the other with 64K of core memory, a CRT and keyboard, an ASR-35 teletypewriter, and a paper tape unit. The instructor station features the Sanders ADDS/5000 CRT display system. Finally, the KC-130F has a number of advanced training features that include demonstration maneuvers, preprogrammed missions, checkrides, and trainee performance evaluation programs.

## **Helicopter Trainers**

One distinct feature of the Vietnam conflict was the coming of age of the helicopter as an all-purpose vehicle — troop carrier, assault vehicle, reconnaissance craft, weapons carrier, land-sea rescue, and many other practical uses. Alert to the potential of the helicopter, the Singer Simulation Products Division instituted a Company-sponsored R&D program, which ultimately led to an NTDC study contract to define a training system for helicopter pilots. The study resulted in a specification and subsequent contract to develop a helicopter trainer. The resultant training system, as well as another developed for the British Royal Air Force, are herein described.

**one of the four-cockpit SFTS  
Complex during in-plant test**

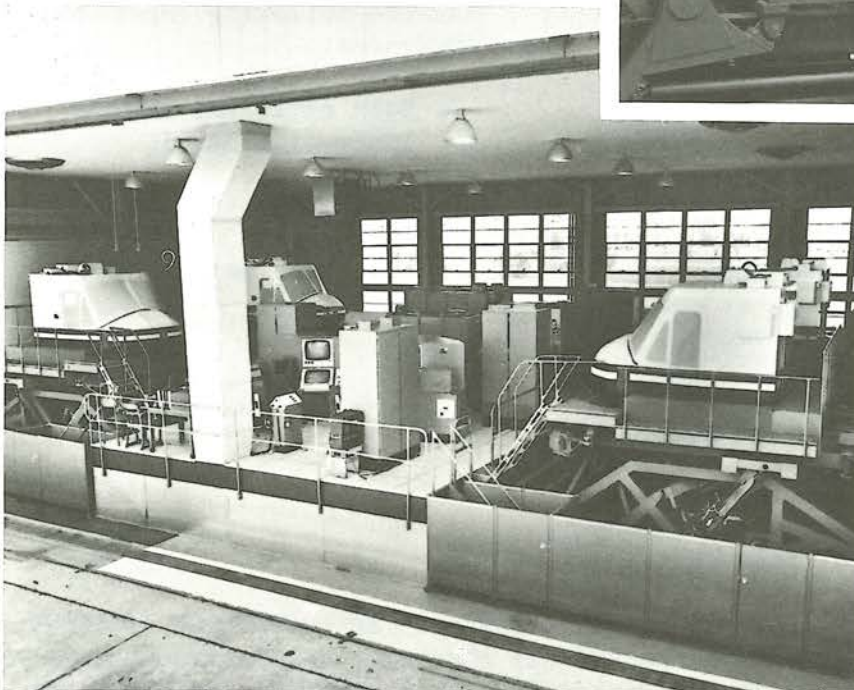

**Device 2B24  
installation at  
Fort Rucker . . .**

## **SFTS, Device 2B24**

Singer Simulation Products Division contracted with the Naval Training Equipment Center to design, fabricate, and demonstrate a prototype Synthetic Flight Training System, designated Device 2B24, for the U.S. Army Materiel Command. The prototype Device 2B24 was installed at the Army's Aviation School, Fort Rucker, Alabama, in January 1971.

The Device 2B24 simulates the flying characteristics of the UH-1H (huey) helicopter. The system comprises four separate cockpits, each with its own five-degree-of-freedom cascaded motion system, an instructor station that can accommodate from one to four instructors and a digital computer complex. The panels and CRT displays on the instructor station are color coded, a different color for each cockpit, to facilitate identification of a particular cockpit's responses.

A second distinguishing feature of Device 2B24 is the advanced training implementation, which employs two advanced concepts - the modular concept and the automated training concept:

- The Modular Concept — Flight training systems have many functions: computation, instrumentation, simulation (student cockpit), and cockpit motion. In the SFTS, a separate module is designed to fulfill each function, thus, modules (functions) may be combined into a subsystem to meet a particular training requirement. For example, a subsystem to meet the requirement for a synthetic training device in the CH-47 transition course would be comprised of a computer module, a CH-47A Operational Flight Trainer (OFT) module, an instructor module, cockpit motion platform, and the appropriate information (program) for the computer module. Should the requirement change to that of a device for VTOL or AAFSS transition training, replacing the CH-47A module with a VTOL or AAFSS OFT module and changing the computer program would meet the new requirement at relatively little cost.
- The Automated Training Concept — Digital computers used in modern training equipment may be programmed to perform many of the routine (repetitive) operations traditionally assigned to the human instructor and to implement such automatic training techniques as adaptive training, demonstration, and programmed instruction. Automatic training has the following important consequences:
  - More efficient use of instructor skills
  - Standardization of training
  - Objective performance evaluation.

The success of Device 2B24 was demonstrated when, in an evaluation of 16 Army student trainees, the average student passed his checkride examination after 5 hours in the aircraft and 35 hours in the Device 2B24 with a better score than students processed in the traditional manner - 60 hours in the aircraft and 26 hours of ground instruction. This achievement was reflected in an initial follow-on order from the Army in December 1972 for four more 2B24 systems.

## **Helicopter Trainers**

One distinct feature of the Vietnam conflict was the coming of age of the helicopter as an all-purpose vehicle — troop carrier, assault vehicle, reconnaissance craft, weapons carrier, land-sea rescue, and many other practical uses. Alert to the potential of the helicopter, the Singer Simulation Products Division instituted a Company-sponsored R&D program, which ultimately led to an NTDC study contract to define a training system for helicopter pilots. The study resulted in a specification and subsequent contract to develop a helicopter trainer. The resultant training system, as well as another developed for the British Royal Air Force, are herein described.

**one of the four-cockpit SFTS  
Complex during in-plant test**

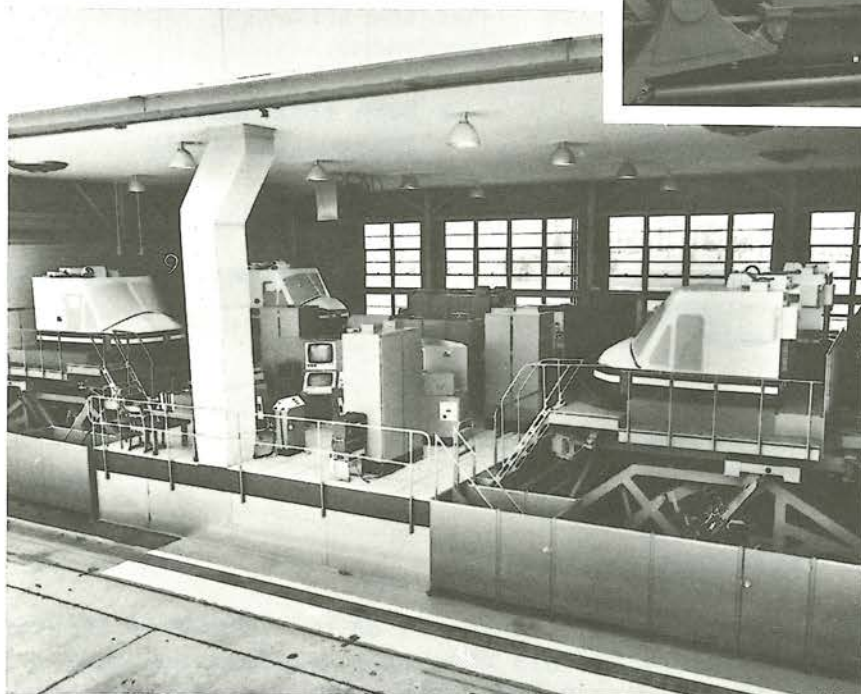

**Device 2B24  
installation at  
Fort Rucker . . .**

# SFTS, Device 2B24

Singer Simulation Products Division contracted with the Naval Training Equipment Center to design, fabricate, and demonstrate a prototype Synthetic Flight Training System, designated Device 2B24, for the U.S. Army Materiel Command. The prototype Device 2B24 was installed at the Army's Aviation School, Fort Rucker, Alabama, in January 1971.

The Device 2B24 simulates the flying characteristics of the UH-1H (huey) helicopter. The system comprises four separate cockpits, each with its own five-degree-of-freedom cascaded motion system, an instructor station that can accommodate from one to four instructors and a digital computer complex. The panels and CRT displays on the instructor station are color coded, a different color for each cockpit, to facilitate identification of a particular cockpit's responses.

A second distinguishing feature of Device 2B24 is the advanced training implementation, which employs two advanced concepts - the modular concept and the automated training concept:

- The Modular Concept — Flight training systems have many functions: computation, instrumentation, simulation (student cockpit), and cockpit motion. In the SFTS, a separate module is designed to fulfill each function, thus, modules (functions) may be combined into a subsystem to meet a particular training requirement. For example, a subsystem to meet the requirement for a synthetic training device in the CH-47 transition course would be comprised of a computer module, a CH-47A Operational Flight Trainer (OFT) module, an instructor module, cockpit motion platform, and the appropriate information (program) for the computer module. Should the requirement change to that of a device for VTOL or AAFSS transition training, replacing the CH-47A module with a VTOL or AAFSS OFT module and changing the computer program would meet the new requirement at relatively little cost.
- The Automated Training Concept — Digital computers used in modern training equipment may be programmed to perform many of the routine (repetitive) operations traditionally assigned to the human instructor and to implement such automatic training techniques as adaptive training, demonstration, and programmed instruction. Automatic training has the following important consequences:
  - More efficient use of instructor skills
  - Standardization of training
  - Objective performance evaluation.

The success of Device 2B24 was demonstrated when, in an evaluation of 16 Army student trainees, the average student passed his checkride examination after 5 hours in the aircraft and 35 hours in the Device 2B24 with a better score than students processed in the traditional manner - 60 hours in the aircraft and 26 hours of ground instruction. This achievement was reflected in an initial follow-on order from the Army in December 1972 for four more 2B24 systems.

## **CH-47 Helicopter Trainer (Device 2B31)**

In June 1973, SPD was contracted to design the prototype for the U.S. Army Material Command's second major helicopter training system, Device 2B31. Device 2B31 will simulate the performance of the CH-47C (Chinook) medium transport helicopter, and will utilize many of the same worthwhile features of the 2B24. However, the 2B31 will also be unique in certain aspects. It will be a single-cockpit installation, will simulate a tandem rotor configuration, and will have a compact instructor station located inside the cockpit behind the pilot/trainee. Finally, the 2B31 will have a sophisticated camera model visual display system.

Like the 2B24, the 2B31 will use the DDP-516 computer. The complex will comprise two central processing units with intercomputer communication unit, each with 32K of core memory, two disk files, two ASR-35 teletypewriters, and a card reader and punch.

The instructor station will be located in the cockpit behind the pilot/trainee, enabling the instructor to watch the trainee. To enable the instructor to observe the visual presentation on his CRT display, the display system will include a raster-scan mode with stroke overwriting capability.

The 2B31 Camera Model Visual System will employ an advanced visual (Scheimpflug-corrected) probe, which enables improved depth of focus at any altitude above the model. The model system will measure 24 by 72 feet, and will use two different scale-factored models: one of 1:250 and the second of 1:000. The system will enable training in basic powered flight, SAS-off flight, ground taxi, takeoff to hover, takeoff from and approach to ground or hover, standard autorotation, running landing, landing from hover, landing rollout, missed approach and go-around, circling and 180° overhead approach, confined area landing, and pinnacle and sling load operations.

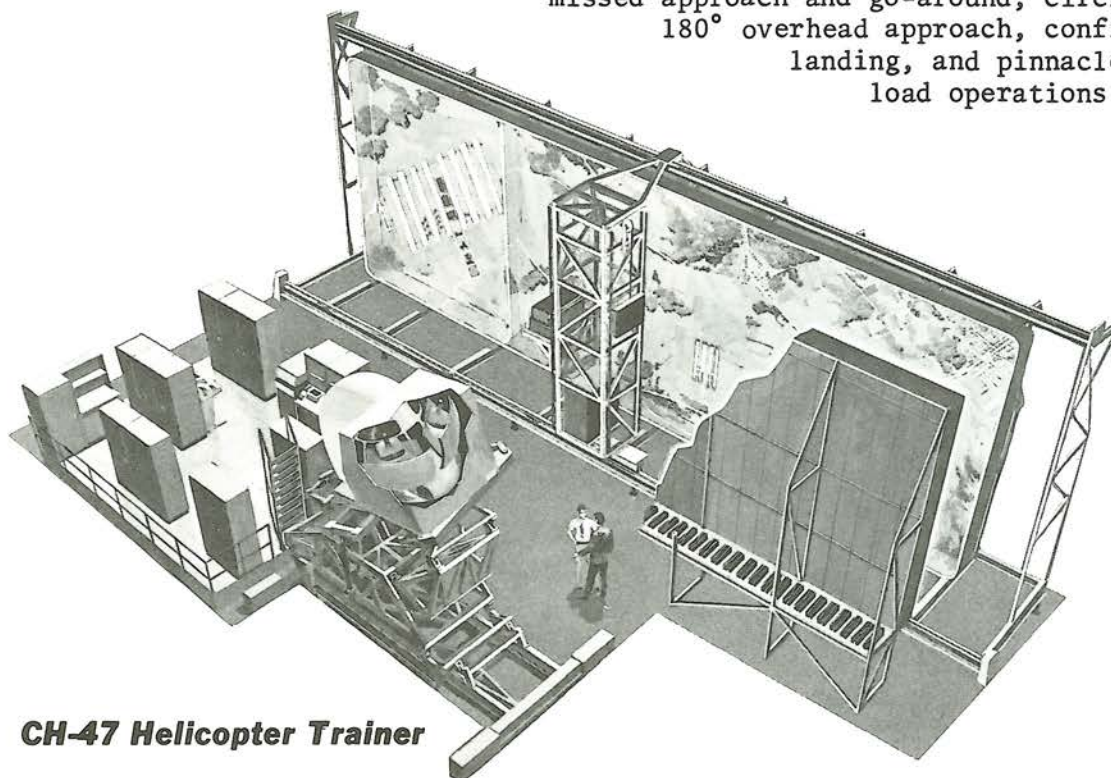

**CH-47 Helicopter Trainer**



## **Sea King Helicopter Trainer**

Another Singer helicopter trainer, the Sea King, was delivered to the British Royal Navy in 1970 to train antisubmarine warfare (ASW) crews. The Sea King simulator comprises two parts: a reproduction of the flight compartment mounted on a three-axis motion system, and a static crew station, each under the control of its own instructor station. Thus, pilots and flight crews can either conduct independent training exercises or carry out fully integrated training missions. Full ASW missions are simulated in the Sea King, including operation of the following systems:

- Navigational Doppler
- Search Radar
- Transponder Interrogation Radar
- Submersible Sonar Transducer
- Weapon Release System

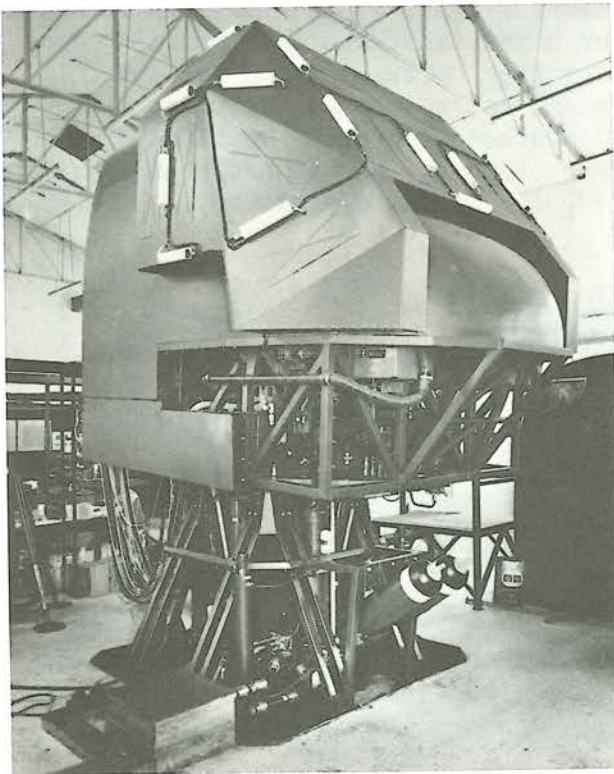

The instructor station is equipped with facilities for generating target information and for setting a wide variety of environmental conditions. A twin CRT monitoring system is also provided to display a constantly updated picture of the tactical area — aircraft, surface vessels, submarines, and details of wind, visibility and sea state.

***the Sea King trainer at Link-Miles***

## **Harrier VTOL Simulator**

Three Harrier Vertical Takeoff and Landing (VTOL) simulators were developed and manufactured by the Simulation Products Division for the British Ministry of Aviation Supply. The Harrier Simulator enables a pilot to carry out a full training mission, including vertical and conventional takeoff and landing, high and low altitude flight, map reading at low flight levels, and weapon attacks against specific targets. All cockpit systems are faithfully reproduced including the head-down moving map display, the latter being integrated with the weapon aiming and release system.

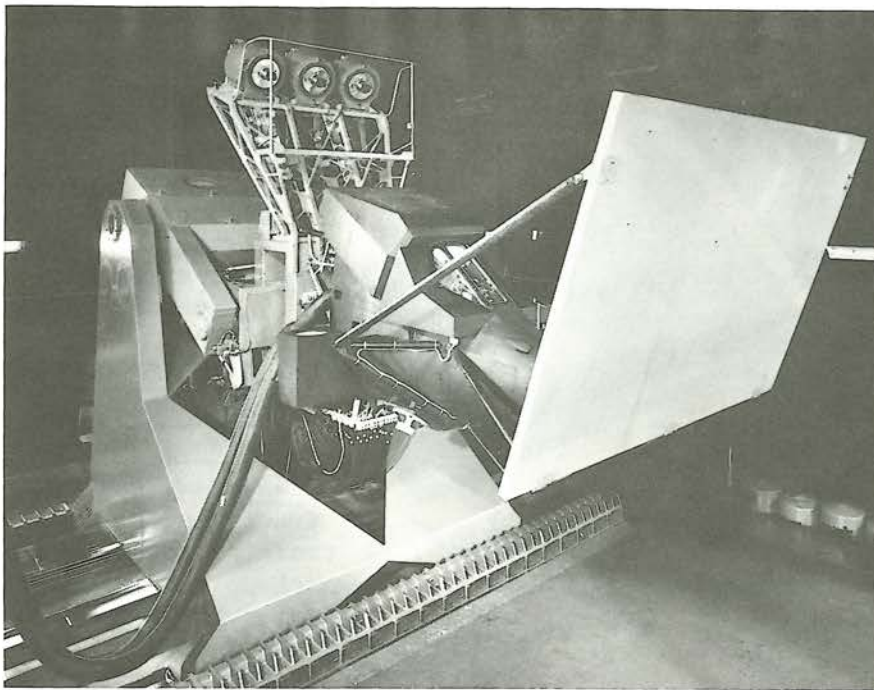

An important feature of the Harrier Trainer is its full-color, closed-circuit television visual system, which utilizes three separate terrain models.

The U.S. Marine Corps will also possess a Harrier Simulator under a contract awarded to Singer in April 1972. The Marine device will be used to train pilots of the AV-8A—the Marine version of the Harrier aircraft.

**Harrier Trainer at RAF - Wittering showing  
4-axis Motion System and visual projection equipment**

## Anti-Submarine Warfare (ASW) Trainers

The Simulation Products Division's Silver Spring Operations is the recognized authority in the development of Anti-Submarine Warfare aircraft simulators as well as maritime simulators, and has designed and manufactured approximately 25 different ASW simulator configurations over the past 20 years. ASW aircraft simulators are not only concerned with the flight environment but also with an ocean environment as it relates to underwater sounds and sensors such as sonar and radar.

### P-3C ASW Trainers

The P-3C program for the Naval Training Device Center involved three separate contracts for three different types of trainers:

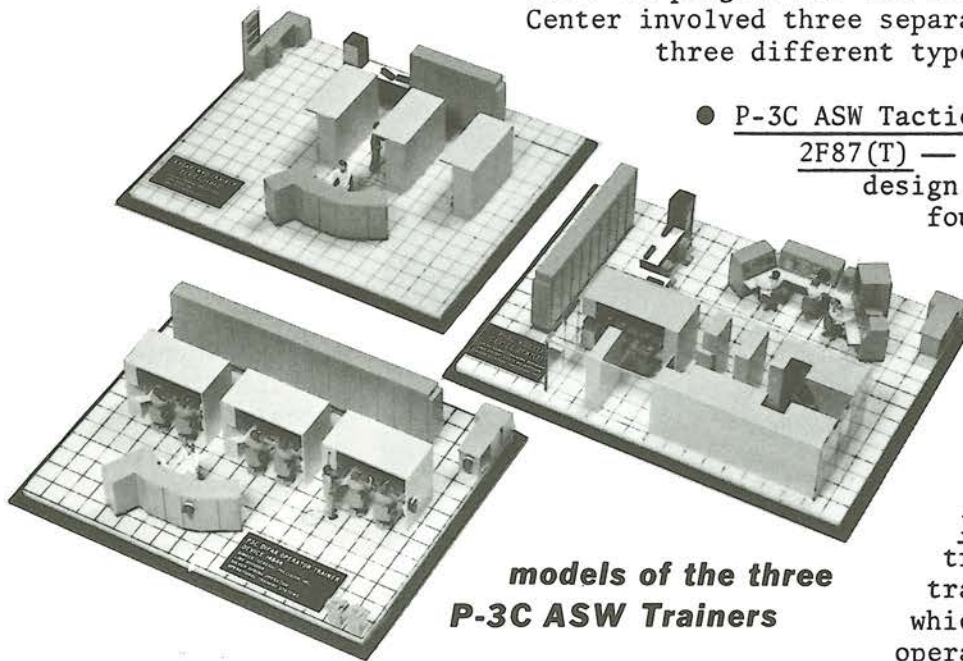

**models of the three  
P-3C ASW Trainers**

- P-3C ASW Tactics Trainer, Device 2F87(T) — This effort was for design and manufacture of four systems to train P-3C crews in ASW tactics and operation of sensor systems.
- P-3C ASW Acoustic Sensor Operator Trainer, Device 14B44 — This contract was for two training facilities in which up to six acoustic operator trainees could be trained in the operation of acoustic sensor equipment in Sensor Stations 1 and 2 of the P-3C Weapon System.
- P-3C ASW Radar/MAD Operator Trainer, Device 14B40 — Two systems were required to provide concentrated training in the operational and tactical application of the Radar/MAD equipment for Sensor Station 3 of the P-3C Weapon System.

## **Harrier VTOL Simulator**

Three Harrier Vertical Takeoff and Landing (VTOL) simulators were developed and manufactured by the Simulation Products Division for the British Ministry of Aviation Supply. The Harrier Simulator enables a pilot to carry out a full training mission, including vertical and conventional takeoff and landing, high and low altitude flight, map reading at low flight levels, and weapon attacks against specific targets. All cockpit systems are faithfully reproduced including the head-down moving map display, the latter being integrated with the weapon aiming and release system.

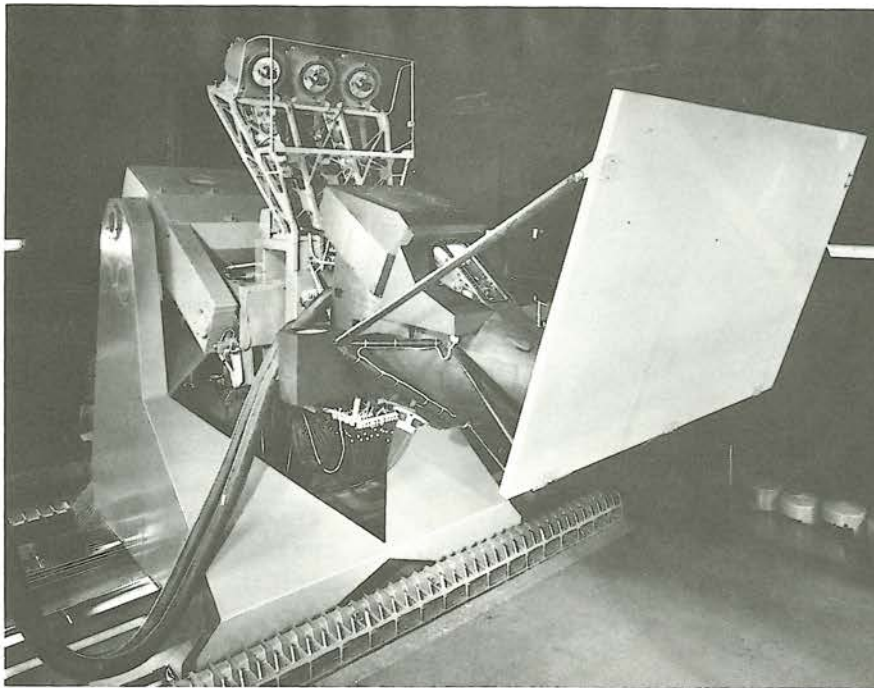

An important feature of the Harrier Trainer is its full-color, closed-circuit television visual system, which utilizes three separate terrain models.

The U.S. Marine Corps will also possess a Harrier Simulator under a contract awarded to Singer in April 1972. The Marine device will be used to train pilots of the AV-8A—the Marine version of the Harrier aircraft.

**Harrier Trainer at RAF - Wittering showing 4-axis Motion System and visual projection equipment**

## Anti-Submarine Warfare (ASW) Trainers

The Simulation Products Division's Silver Spring Operations is the recognized authority in the development of Anti-Submarine Warfare aircraft simulators as well as maritime simulators, and has designed and manufactured approximately 25 different ASW simulator configurations over the past 20 years. ASW aircraft simulators are not only concerned with the flight environment but also with an ocean environment as it relates to underwater sounds and sensors such as sonar and radar.

### P-3C ASW Trainers

The P-3C program for the Naval Training Device Center involved three separate contracts for three different types of trainers:

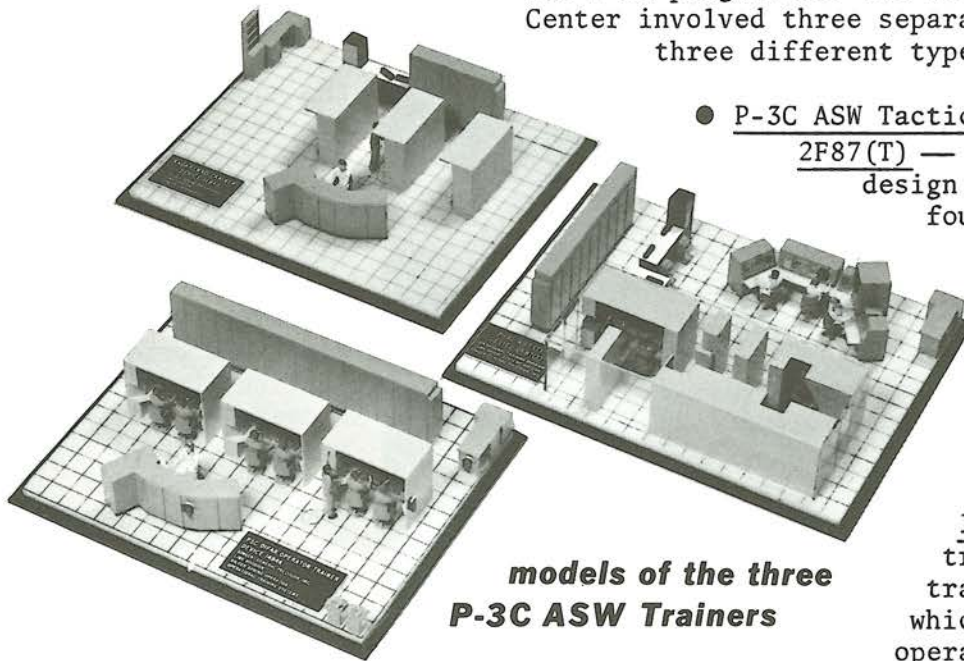

**models of the three  
P-3C ASW Trainers**

- P-3C ASW Tactics Trainer, Device 2F87(T) — This effort was for design and manufacture of four systems to train P-3C crews in ASW tactics and operation of sensor systems.
- P-3C ASW Acoustic Sensor Operator Trainer, Device 14B44 — This contract was for two training facilities in which up to six acoustic operator trainees could be trained in the operation of acoustic sensor equipment in Sensor Stations 1 and 2 of the P-3C Weapon System.
- P-3C ASW Radar/MAD Operator Trainer, Device 14B40 — Two systems were required to provide concentrated training in the operational and tactical application of the Radar/MAD equipment for Sensor Station 3 of the P-3C Weapon System.

## S-3A ASW Trainers

The S-3A Mission Simulator is designed to train four-man crews for the carrier-based, twin-engine, antisubmarine warfare (ASW) S-3A aircraft presently being built by Lockheed. The crew stations and functions simulated include the Pilot, Copilot, Tactical Coordinator (TACCO), and Sensor Operator (SENSO).

The S-3A Simulator has four basic modes of operation:

- Flight Mode - Only the pilot and copilot stations are manned. The flight operator establishes the aircraft configuration setup via controls and a data display terminal, and the flight instructor monitors crew performance and introduces malfunctions as deemed appropriate.
- Tactics Mode - The TACCO and SENSO stations are manned and operational. Inputs normally provided by the pilot and Copilot are furnished by the tactics operator, and the tactics instructor performs "over the shoulder" monitoring.
- Simultaneous/Independent Mode - The simulator is capable of simultaneous but independent operation in both flight and tactics modes without restriction to training effectiveness. This capability is facilitated by a programming design technique that enables the simulator computer to simulate systems that are shared between the flight and tactics functions.
- Integrated Mode - All four crew stations are manned and operational, and all functions are performed normally in a single coordinated mission.

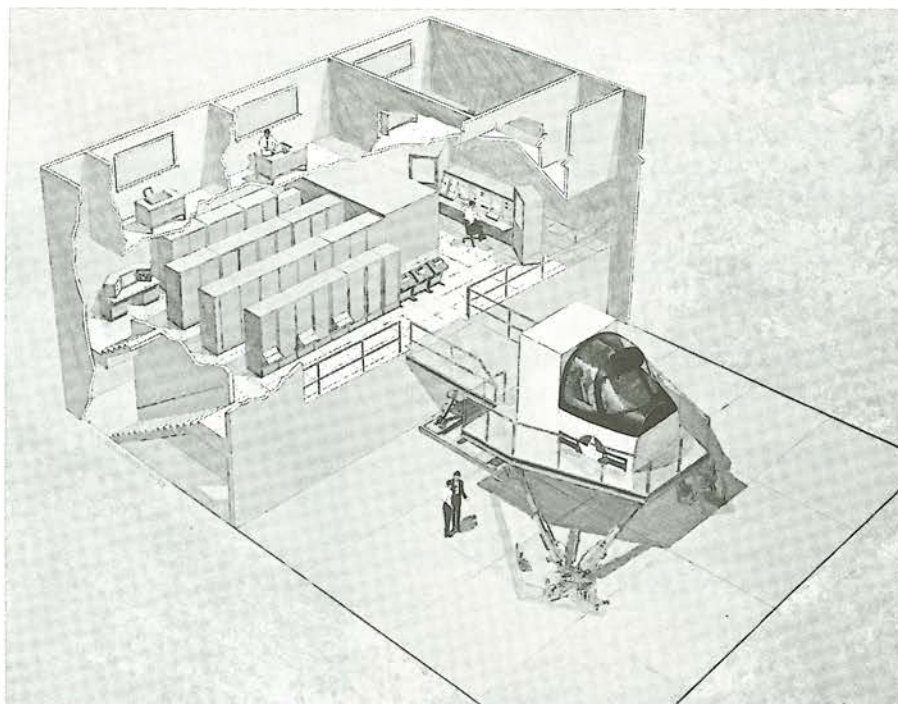

**S-3A WST artist's conception**

## **Tank Trainers**

Both flight simulation and driver trainer experience have had application to the study and design of driving trainers for battle tanks. Two Singer programs are briefly described in this section.

### **Main Battle Tank-70 study**

The Simulation Products Division performed a study for the U.S. Army under an NTDC contract, the objectives of which were to determine the following for the Main Battle Tank-70:

- Determine personnel responsibilities and training requirements in tank operation and maintenance and of current U.S. Army armor training capabilities.
- Formulate a preliminary training concept defining appropriate training devices for training system.
- Definitize tradeoffs necessary to obtain the training system and device concepts best suited to fulfill the identified training requirements.
- Prepare a final report recommending the training organization and general characteristics of the devices to be developed.

## **Chieftain Tank Trainer**

The Chieftain Tank Simulator produced for the British Army comprised the following main items:

- Replica of the driver compartment
- Instructor station adjacent to the driver compartment
- Driving simulator sound system
- Closed-circuit television model visual system

**driver station, Chieftain . . .**

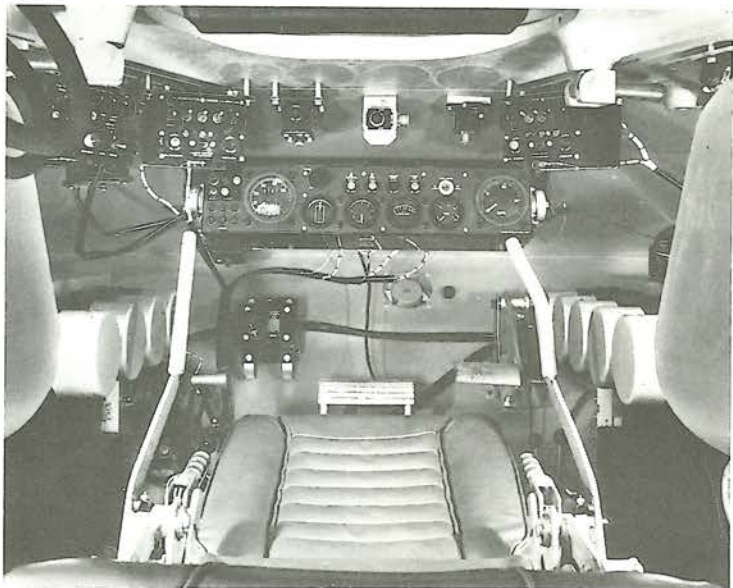

# Research Simulators

Today's simulators and training techniques are the direct result of yesterday's experimentation, while the configuration of tomorrow's trainers is being determined right now. For example, the Simulation Products Division has recently been engaged in design of two experimental training systems: the ASUPT program to provide a research tool for the design of future trainers to advance the U.S. Air Force's Undergraduate Pilot Training Program; and the second, a dual-cockpit training system, also for the Air Force, to be used for manifold air-to-air combat-related research such as the development of new aerial combat techniques and maneuvers, and evaluation of the performance of new aircraft and tactical weapons in air-to-air combat. The diversity of purposes of these two programs alone indicates the versatility and flexibility of simulators for experimentation and research.

Aircraft manufacturers have also found that a digital flight simulator is an excellent research tool to use in evaluating and, in some cases, determining the design and performance of new aircraft, even while they are still in the design stage. Most recently, the Simulation Products Division has been supporting Grumman in their F-14 and E-2C development programs and North American Rockwell on the B-1 program.



## **Research Simulator Facility Maintenance**

The Simulation Products Division familiarity with research simulators goes beyond design and fabrication; for several years, the Division was under contract to the Air Force to operate and maintain their Crew Station Simulation Facility (CSSF). The CSSF is used not only as a training facility but also as a training research center in which to test and evaluate new training techniques and simulation systems. Singer engineers and technicians performed mechanical and software design, integration, and checkout of experimental changes and improvements to the training systems—as well as routine simulator operation and maintenance. A similar function is also provided to the NASA Manned Spacecraft Center for which the Simulation Products Center has been contracted by the National Aeronautics and Space Administration since 1965

## **Advanced Simulation in Undergraduate Pilot Training (ASUPT)**

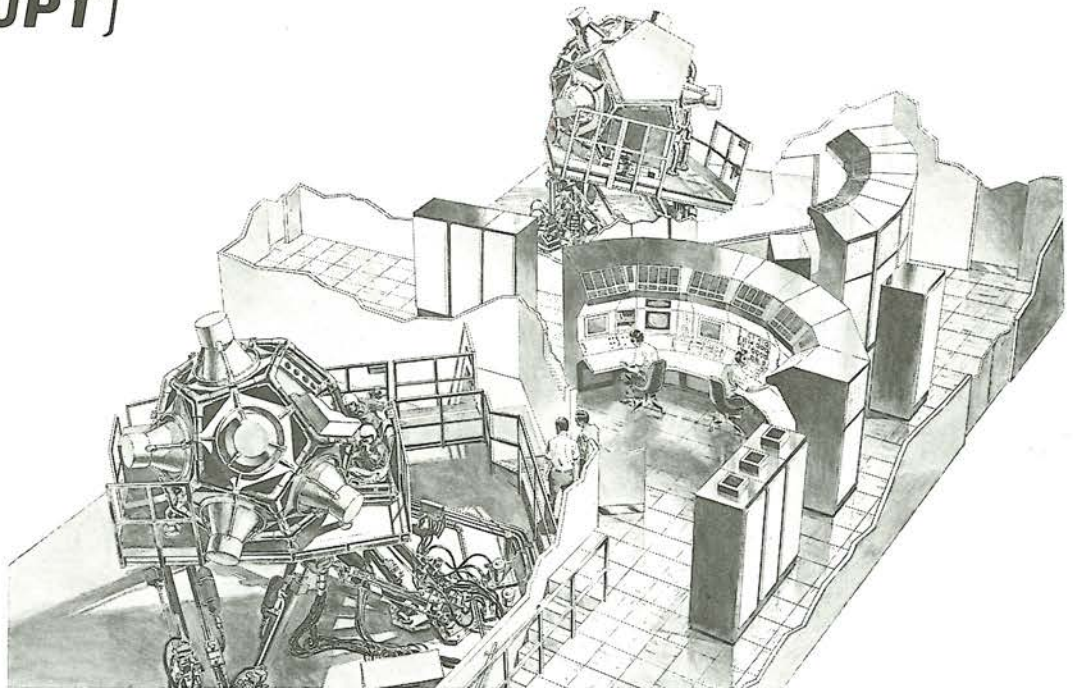

The ASUPT effort was contracted to the Singer-Simulation Products Division in late 1970 for the design and construction of a state-of-the-art research training tool that could be used to extend and enhance the quality of USAF pilot training. The ASUPT system, two of which were ordered, consists of a fighter cockpit on a six-degree-of-freedom motion system and a new 7-channel, wrap-around visual display system, which was designed under subcontract by the Farrand Optical Company.

The ASUPT software (computer programs) employs a modular concept to facilitate and expedite experimentation and change. In the conventional computation system, changes to programs are accomplished by "patch" routines, which are eventually incorporated into the new "load" by extensive and laborious programming. However, as patches are entered into the ASUPT simulation, the linking editor program automatically integrates them into the master program, allocates the necessary disc area, and produces a "master load" copy of the updated software.

The second feature of the ASUPT that deserves special mention is that it has three different types of instructor stations to permit experimentation and evaluation of different modes and techniques of instruction. The instructor stations also provide flexibility in setting up experiments, in controlling, recording, and interpreting trainee performance parameters, and in ease of evaluation and operation. Finally, direct comparative analyses of the merit of each of the three types of instructor stations can be made to indicate the more promising configurations for future Air Force trainees.

## ***Simulator for Air-to-Air Combat***

The Singer-Simulation Products Division was selected by the USAF Aeronautical Systems Division (Contract No. F33657-72-C-0639) to design and fabricate the Simulator for Air-to-Air Combat (SAAC) facility for use in advancing capabilities in air-to-air combat techniques and tactics evaluation. The SAAC system is intended to serve as: (1) a research tool for evaluation of fighter aircraft and tactical weapons design for use in air-to-air combat; (2) a vehicle for development and evaluation of air-to-air combat techniques and low-risk training and maintenance of proficiency in those techniques; and (3) a basic device that can be used to determine the required simulation of critical flight, tactical weapon scoring, visual, motion, and other environmental characteristics to meet future training goals.

The SAAC system consists of two F-4 aircraft simulator cockpits, each with its own six-degree-of-freedom motion system, G-seat with vibration and buffet simulation, and visual system that includes an eight-window display, a camera model aircraft image generator, and a synthetic terrain generator. The SAAC digital computer complex has a three-XDS Sigma 5 multiprocessor configuration with capability for future expansion.

Flexibility is the keynote to design to facilitate the widest possible latitude in experimentation, not only for software modification as flight and tactical performance characteristics are altered or added, but also for modification to the cockpit hardware as experimental and new aircraft designs and configurations are tested. Both F-4 cockpits are capable of modification to represent various other fighter aircraft and the capacity for change also holds true for the model assemblies.

The sophisticated visual system presents an image of the other aircraft model to each of the cockpits, thus giving each pilot an infinity image representation of the maneuvering of his adversary.

The visual system depicts not only the aircraft represented by the other cockpit but also terrain and sky environment and such visual representations as the operation of speed brakes and afterburner and gun and missile "hits".

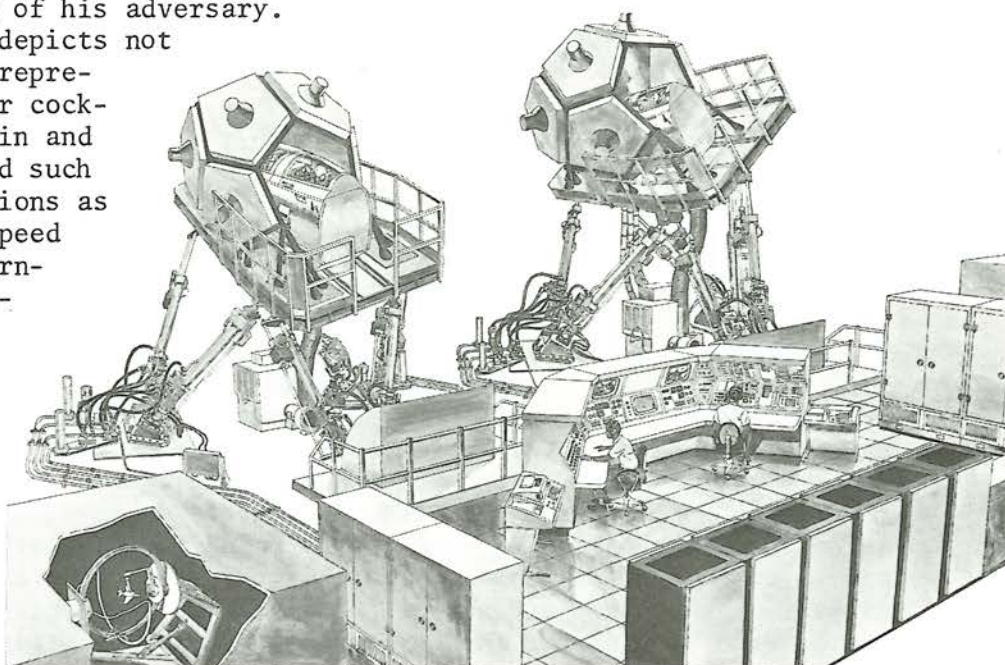

# Space Simulators

Singer entered the space age on the Gemini program, a simulator which used a Singer Mark I digital simulation computer in conjunction with a DDP-24. The Simulation Products Division also generated, programmed, and debugged the system equations and participated in overall simulation test. In addition to the programs that followed, which are described herein, Singer has been under contract to NASA since 1965 for the Simulation Complex (SIMCOM) effort. This effort involves maintenance, repair, and modification of all Manned Spacecraft Center simulation and training equipment located in Houston, Texas, and Cape Kennedy, Florida.

## ***the Space Shuttle***

The Simulation Products Division is currently participating in the latest American venture in space exploration — The Space Shuttle Program. Singer embarked on this newest space effort when contract NAS-9-12836 was awarded in June of 1972 by the National Aeronautics and Space Administration for a Study of Space Shuttle Simulation Requirements. The Study is intended to produce detailed specifications for the simulation systems that will most effectively train astronauts to perform the difficult tasks associated with shuttling personnel and equipment back and forth between earth and orbiting space stations. Unlike training for the Apollo mission, astronauts must additionally learn to pilot the Space Shuttle during reentry into the earth's atmosphere and land it in the same manner as a conventional aircraft

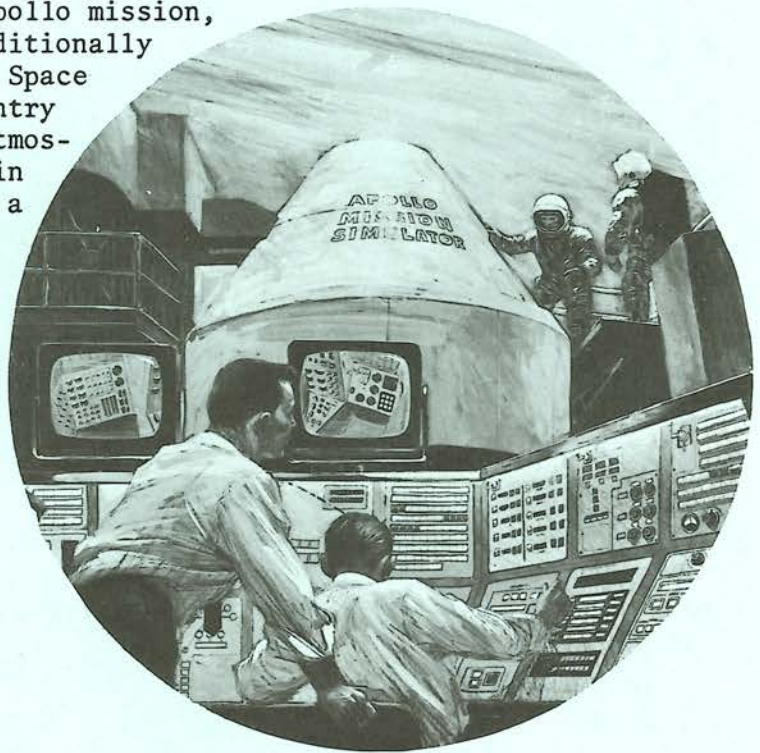

## **Edwards Space Flight Trainer**

Late in 1964, Singer delivered the Edwards Space Flight Trainer to the Aerospace Research School, Edwards Air Force Base, California. The trainer approximates the flight regimes of most types of spacecraft conceived at that time and fulfills the training objectives of the Aerospace Research School.

The Edwards Space Flight Trainer was the first space trainer program for which Singer had total responsibility. It incorporates provisions for accommodating new complexities of space flight and vehicle performance as future vehicles are introduced. Subcontractors to Singer were the Hughes Aircraft Company (cockpit displays and controls), American Machine and Foundry (motion system and safety station), and Farrand Optical Company (infinity image visual system), and Singer as prime contractor provided the cockpit, computer, instructor station, rendezvous and docking portion of the visual system, and overall integration and installation of the completed trainer.

The computer complex for the Edwards Space Flight Trainer is composed of digital and analog computers. It utilizes the Singer-developed Mark II digital computer, combined with the necessary peripheral equipment to translate the digital outputs of the Mark II into proper analog form for simulation purposes, and a general-purpose analog computer (EAI Pace Model 231's), plus the necessary interface equipment to integrate the digital and analog computers into a unified, highly flexible facility. The accuracy necessary in the calculations of flight trajectories, position, guidance equations, and other equations is achieved by digital computation in the Mark II computer.

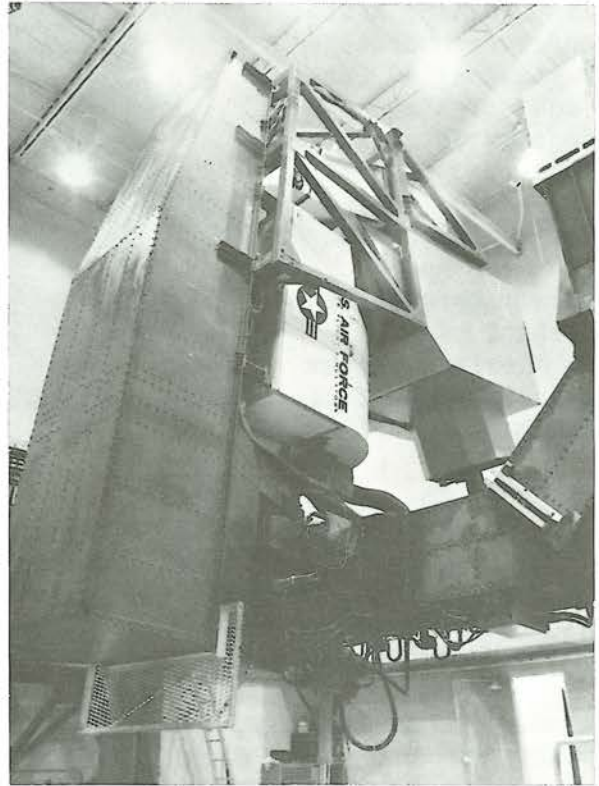

**the Edwards Air Force Base  
Space Flight Trainer**

## **Apollo Command Module Simulator**

Early in the Apollo Program, Singer received a contract for the Command Module Simulators (CMS) — one was installed in November 1965, at the Manned Spacecraft Center in Houston, Texas, and two were installed at Kennedy Space Center, Florida. These facilities, the largest and most complex training installations ever undertaken (each standing 30 feet high and weighing approximately 40 tons), were designed to provide effective training for the astronaut crews of the Apollo spacecraft throughout every phase of the Apollo Mission. These installations and facilities were completed in 1968.

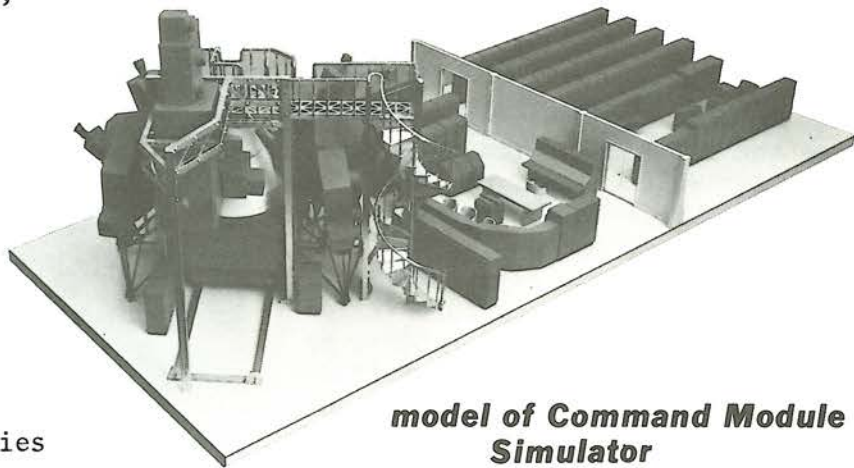

**model of Command Module Simulator**

The CMS duplicates all phases of the Apollo mission from prelaunch through lunar module separation and rendezvous to earth reentry and landing. The simulator also provides sound effects, space lighting effects to enable astronauts to see the earth and moon during all mission phases, food, water, and waste systems, and heat to the astronauts' suits to simulate reentry temperatures.

To provide extreme reality, the simulators are integrated with the Manned Spacecraft Control Center (MSCC); thus, the astronauts are in contact with the real-world network of monitoring stations. A visual display system provides for out-the-window visual display simulation. Realistic rendezvous and docking views are provided by high-resolution closed-circuit TV viewed through the basic out-the-window systems at the two docking windows and at the telescope.



**the Apollo CMS complex**

# ***Apollo Lunar Module Simulator***

In 1968, the Simulation Products Division completed its contractual commitments to Grumman Aircraft Engineering Corporation for the design, development, and fabrication of two Lunar Module Simulators (LMS). The Lunar Module Simulators were installed at NASA's Manned Spacecraft Center, Houston, and Kennedy Space Center and were integrated for use with the two Apollo Command Module Simulators also produced by Singer. Astronauts preparing for the trip to the moon used both simulators to prepare for the entire Apollo mission.

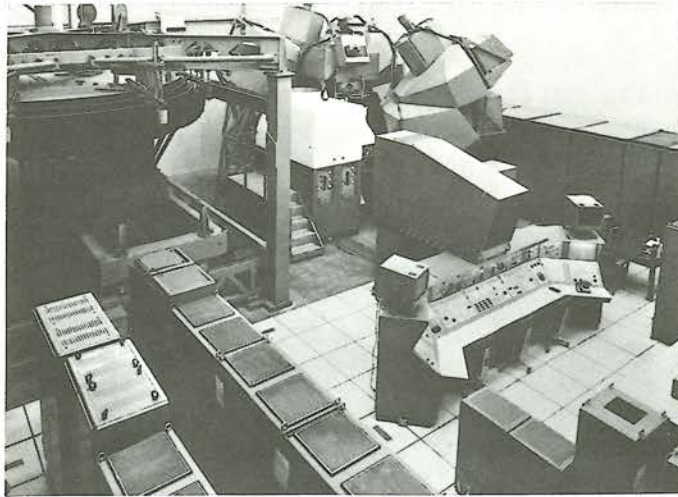

***Lunar Module Simulator installation***

The simulated lunar mission begins in the Apollo Command Module Simulator, as if awaiting the countdown on the launch pad at Kennedy Space Center. The three crew members inside the simulator exercise launch, first- and second-stage boost and separation, parking and earth orbits, insertion into trans-lunar trajectory, transposition (Command/Service Module turn-around maneuver), initial and midcourse correction, circumlunar pass, pre-retro coast, retro-to-circumlunar orbit, and circular lunar orbit. Furthermore, the stars, moon, and earth are visible to the astronauts at all appropriate times. To simulate the lunar surface, a lunar visual system and a landmass simulator are utilized.

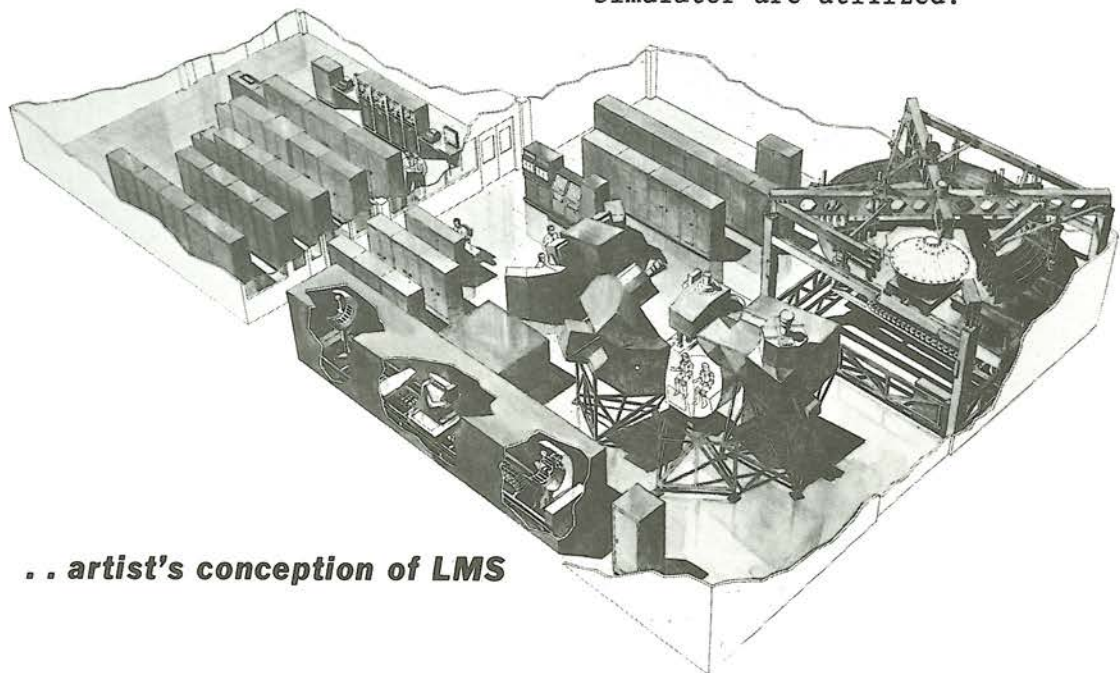

***.. artist's conception of LMS***



## ***Skylab Simulator***

The Skylab Simulator was delivered to and accepted by NASA Manned Spacecraft Center, Houston, Texas, during the last quarter of 1971. This simulator provides realistic simulation of Skylab systems/equipment, including the performance of various experiments related to the Skylab Mission. The simulator uses an IBM 360 Model 65 Computer, and employs a CRT system for the Instructor-Operator stations.

Singer demonstrated its ability to develop and produce complex systems/equipment in a minimum time period by having the simulator accepted three weeks ahead of schedule.

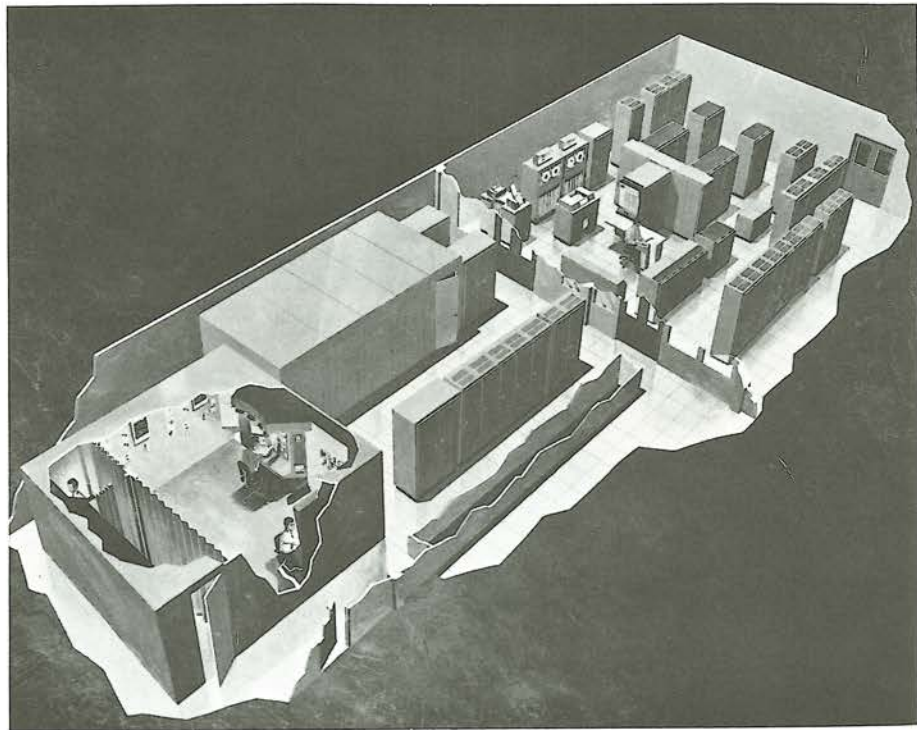

***Skylab complex***

# ***Apollo Lunar Module Simulator***

In 1968, the Simulation Products Division completed its contractual commitments to Grumman Aircraft Engineering Corporation for the design, development, and fabrication of two Lunar Module Simulators (LMS). The Lunar Module Simulators were installed at NASA's Manned Spacecraft Center, Houston, and Kennedy Space Center and were integrated for use with the two Apollo Command Module Simulators also produced by Singer. Astronauts preparing for the trip to the moon used both simulators to prepare for the entire Apollo mission.

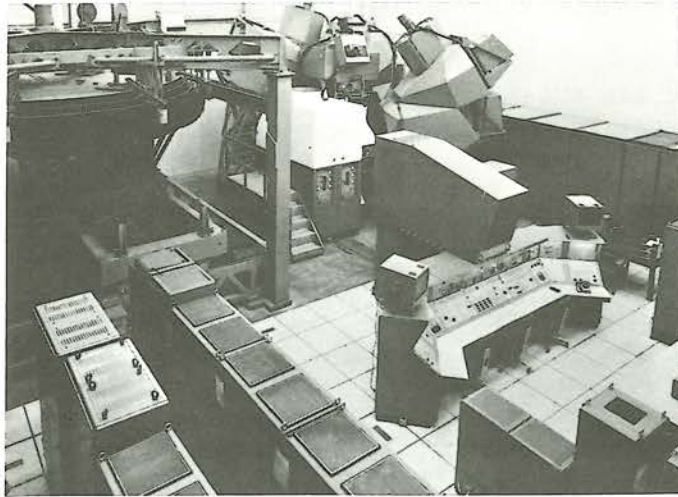

***Lunar Module Simulator installation***

The simulated lunar mission begins in the Apollo Command Module Simulator, as if awaiting the countdown on the launch pad at Kennedy Space Center. The three crew members inside the simulator exercise launch, first- and second-stage boost and separation, parking and earth orbits, insertion into trans-lunar trajectory, transposition (Command/Service Module turn-around maneuver), initial and midcourse correction, circumlunar pass, pre-retro coast, retro-to-circumlunar orbit, and circular lunar orbit. Furthermore, the stars, moon, and earth are visible to the astronauts at all appropriate times. To simulate the lunar surface, a lunar visual system and a landmass simulator are utilized.

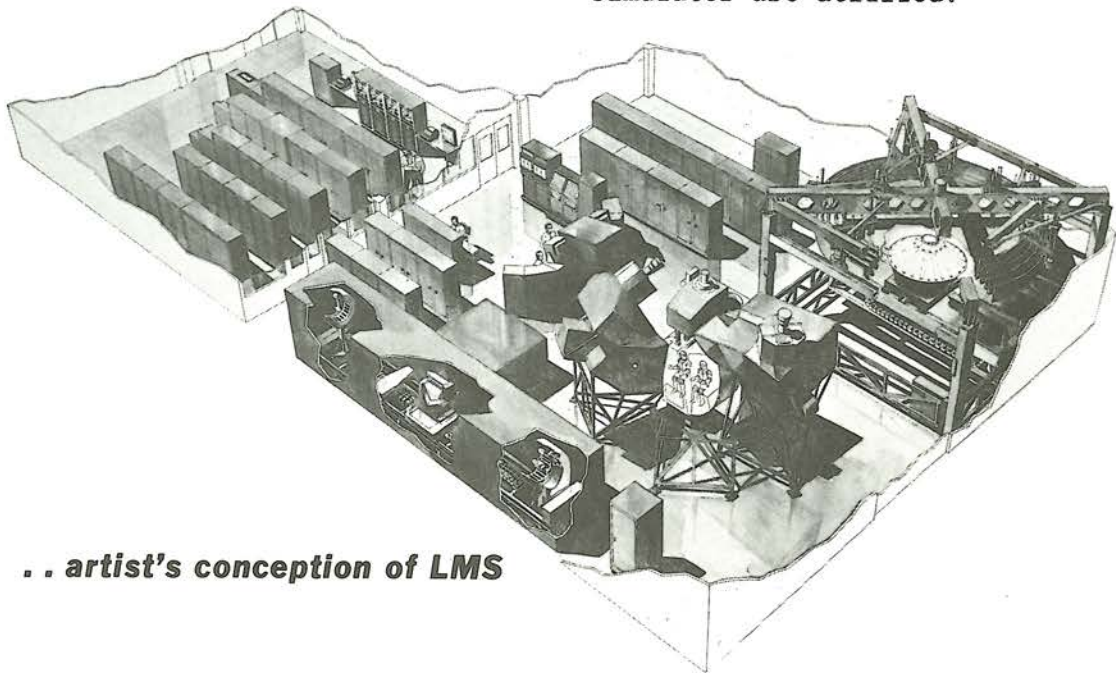

***. . artist's conception of LMS***

## ***Skylab Simulator***

The Skylab Simulator was delivered to and accepted by NASA Manned Spacecraft Center, Houston, Texas, during the last quarter of 1971. This simulator provides realistic simulation of Skylab systems/equipment, including the performance of various experiments related to the Skylab Mission. The simulator uses an IBM 360 Model 65 Computer, and employs a CRT system for the Instructor-Operator stations.

Singer demonstrated its ability to develop and produce complex systems/equipment in a minimum time period by having the simulator accepted three weeks ahead of schedule.

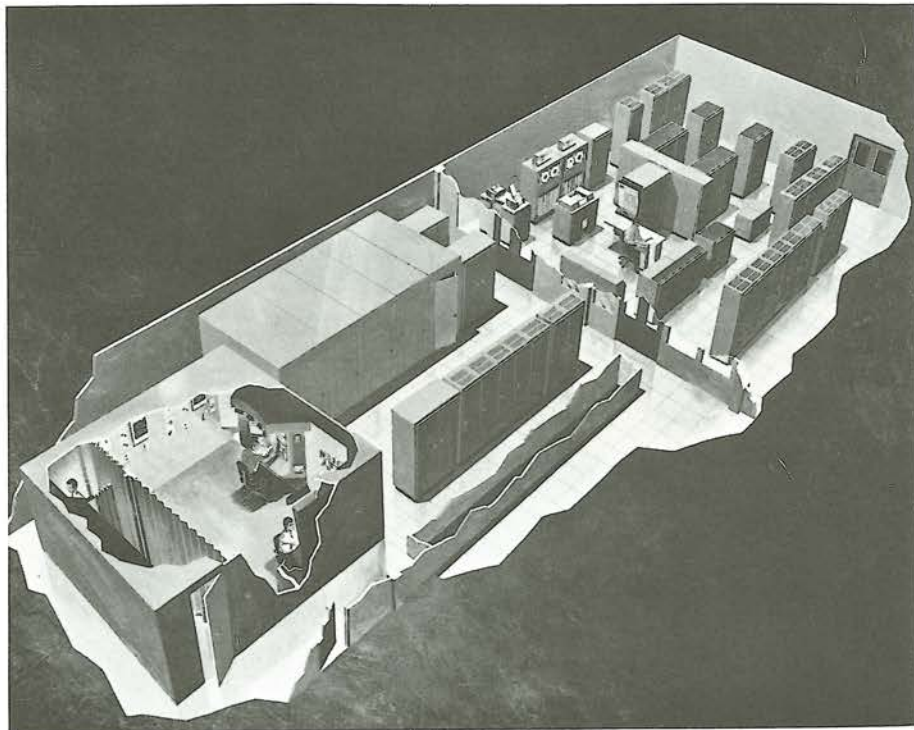

***Skylab complex***

# Maritime Training Systems

Changing shipboard procedures and equipment resulting from technological advances have had a marked impact upon personnel in the maritime industry. To assess this impact, the Singer Simulation Products Division conducted a study of current and projected training and training support requirements for deck officers of the U.S. Merchant Marine. The study results were published and provided the basis for courses conducted in the New Maritime Institute of Technology and Graduate Studies in Baltimore as part of the Maritime Advancement, Training, Education, and Safety (MATES) program.

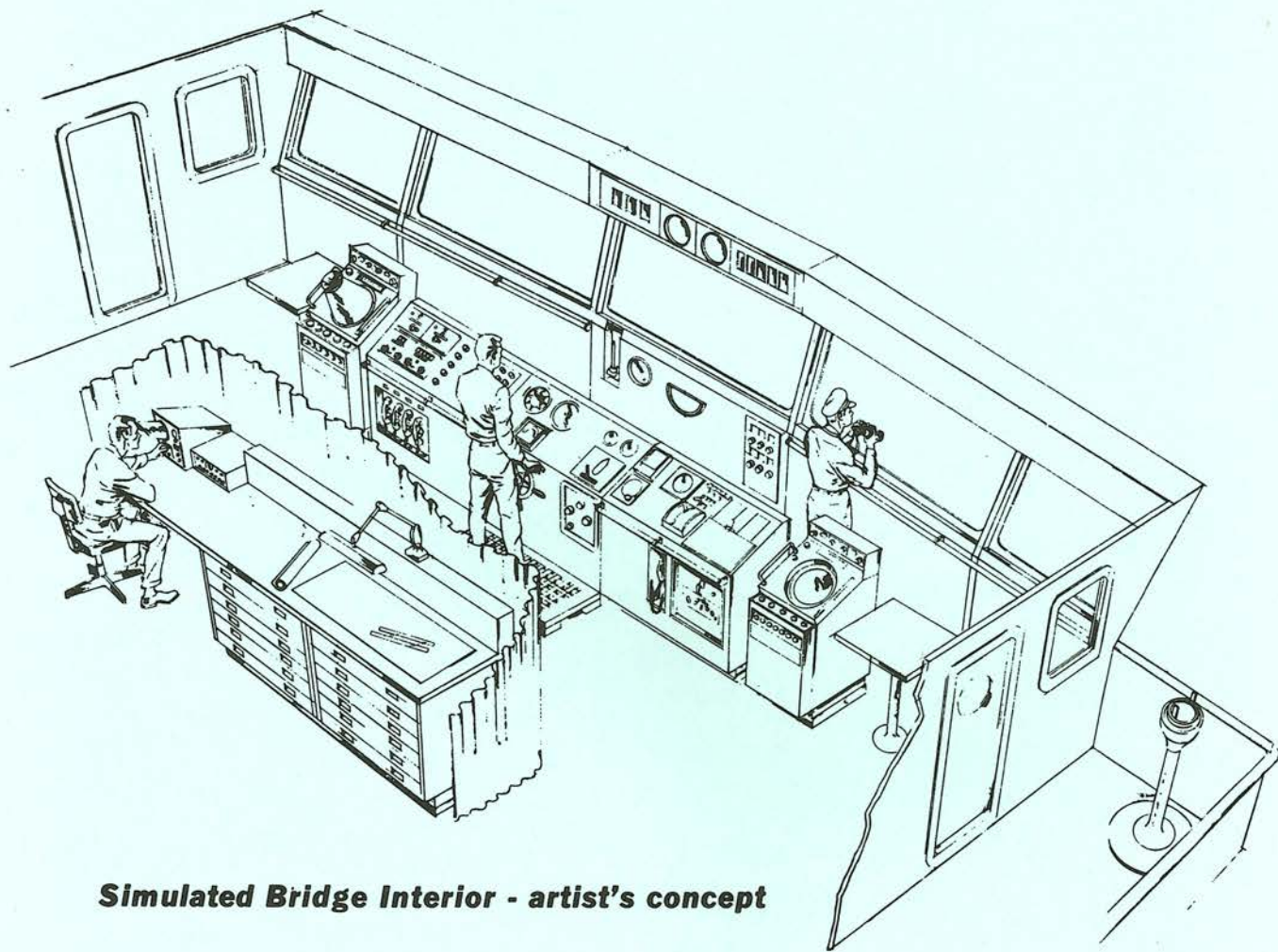

**Simulated Bridge Interior - artist's concept**

## **Collision Avoidance Radar Simulator**

The Collision Avoidance Radar Simulator (CARS) is designed to train Merchant Marine deck officers in the use of radar for collision avoidance and piloting. It has eight trainee cubicles, each containing two radar displays, an ownship control console, two plotting tables, and a reference table. There are two instructor consoles in the CARS, each mounted in modular racks which serve two specific purposes: (a) house the computer interface equipment, power supplies, and logic units required to simulate operational radar equipment or drive meter-movement-type indicators at the trainee stations; and (b) provide the instructor with control and monitoring panels and a suitable writing shelf. A radar display unit from which the instructor may select any associated trainee radar displays for monitoring is pedestal-mounted at the instructor station.

Briefly, the CARS features: (1) 8 independently maneuverable ownships; (2) 8 target vessels maneuverable either by the instructor or automatically; (3) 7 programmed harbor areas (New York, San Francisco, Dover Straits, Rotterdam, Atlantic approach to Panama Canal, Yokahama, Chesapeake Bay entrance); (4) 16 relative and true motion radar displays; (5) ship-to-ship and ship-to-shore VHF communications; and (6) ship's horn simulation for signaling.

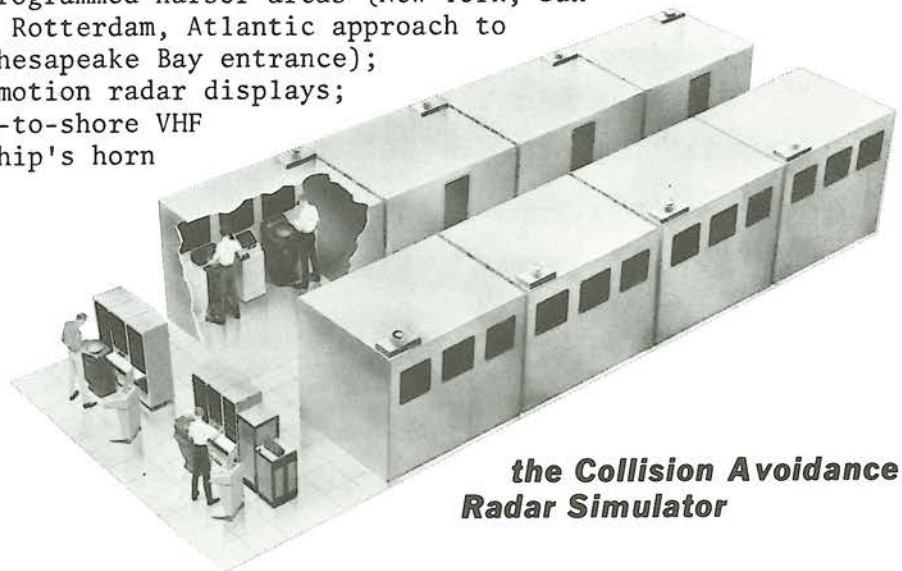

***the Collision Avoidance Radar Simulator***



***Simulator Instructor Console***



***... Trainee station***

**Maritime Training Systems**

# ***Ship Propulsion Plant Simulator***

The Ship Propulsion Plant Operations Training Device is designed primarily to upgrade deck officers' knowledge of modern automated ship propulsion plant operations, and the extent of simulation is more than adequate to permit engineering officers to gain significant training in skills to efficiently operate and troubleshoot a modern automated propulsion system. Simulated systems and effects include: boiler system and associated components, propulsion system and associated components, services systems, component effects on system operation, interaction between systems, alarms (causes and effects), and malfunctions (causes and effects).

Major components of the simulator system include:

- Bridge and engine room consoles
- Pictorial display board
- Instructor's trainer control box
- Hybrid simulation computer

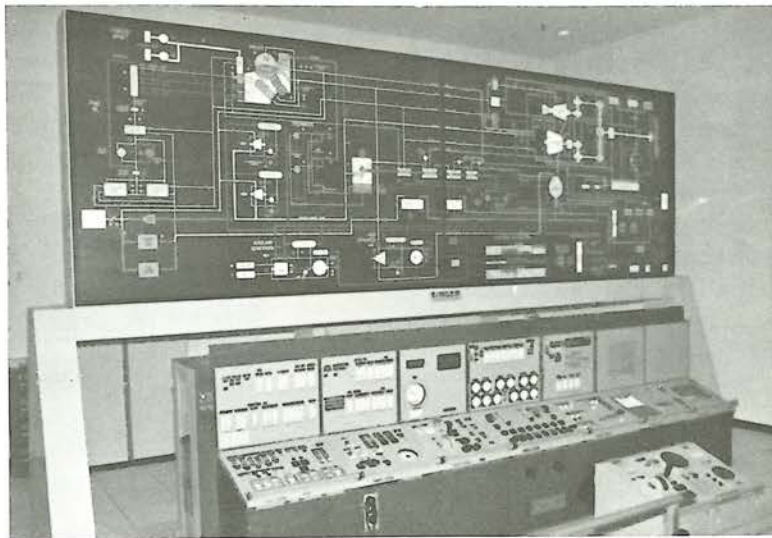

***Ship Propulsion Plant Simulator***

# Collision Avoidance Radar Trainer

The Collision Avoidance Radar Trainer (CART) was originally delivered to the U.S. Army and installed in the Army Transportation School at Fort Eustis, Virginia, in 1967. Then, the system was updated in mid-1969 to include simulation of Loran, ADF, and RDF. Updating was accomplished merely by programming the computer and adding only the hardware required to control the new training problems and to interface with the new trainee stations, thus evidencing the inherent flexibility of the original Simulation Products Division design.

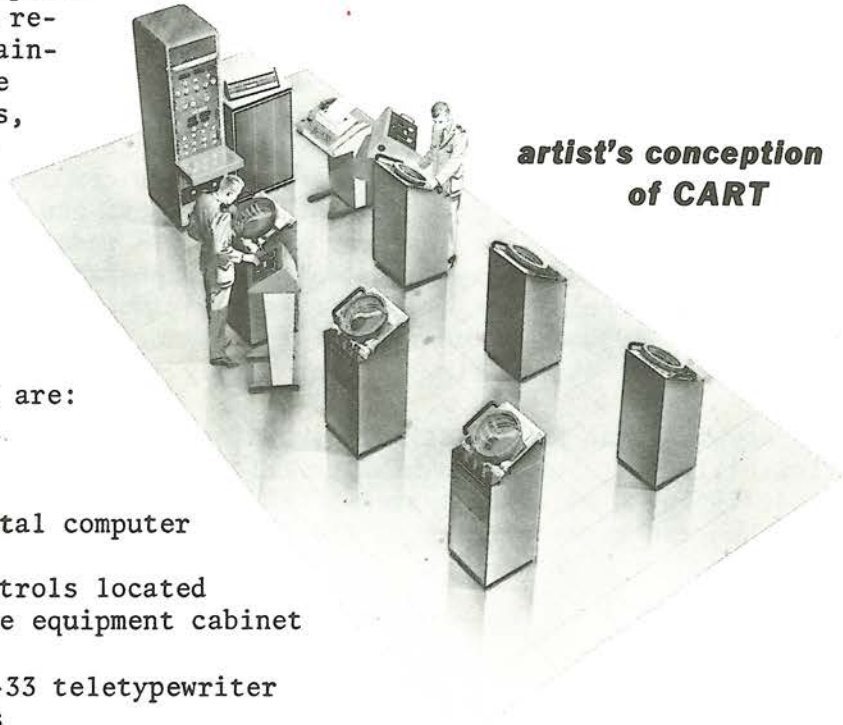

Major components of the CART are:

- Instructor Station

- General-purpose digital computer
- Training problem controls located on front of interface equipment cabinet
- Tape reader and ASR-33 teletypewriter computer peripherals

- Radar Trainee Stations

- Two (2) own-ship radar PPI displays
- Four (4) PPI repeaters (2 slaved to each own-ship PPI)
- Two (2) own-ship maneuver control panels
- Plotting tables adjacent to all 6 radar displays

- Electronic Navigation Trainee Stations

- Two (2) Loran A receivers
- Four (4) receivers capable of receiving both Loran A and Loran C signals
- Four (4) RDF receivers
- Two (2) ADF receivers



# Danish Navy Tactical Simulator

A complex Naval Tactics Simulation Facility was developed for the Royal Danish Navy, and installed in their facility in the Spring of 1972. The system is designed to provide training in radar interpretation and navigation, plotting and navigation decision-making, communications procedures, target and weapons selection, and other tasks pertinent to a wide variety of naval tactical exercises. Major components of the simulator complex include: 12 own-ship CIC/operations-room cubicles, two maritime headquarters (MHQ) cubicles, an exercise control and analysis facility, and a general-purpose computer complex. In response to input data from the own-ship cubicles, MHQ's, and for the exercise and analysis facility, the computer complex determines the dynamics and relative positions of all targets and own-ships, and generates all coastline, target, and IFF/SIF radar video. The accuracy of target and own-ship position computations and the radar range resolution of coastline video within the simulated operations area is better than 50 years. Characteristically of a digital system, repeatability of all computations is absolutely 100 percent.

The Royal Danish Navy Tactical Simulator once again demonstrates the flexibility of simulation as a training tool and Singer's expertise in designing simulation systems. The system provides 48 targets, each of which can represent any of the following:

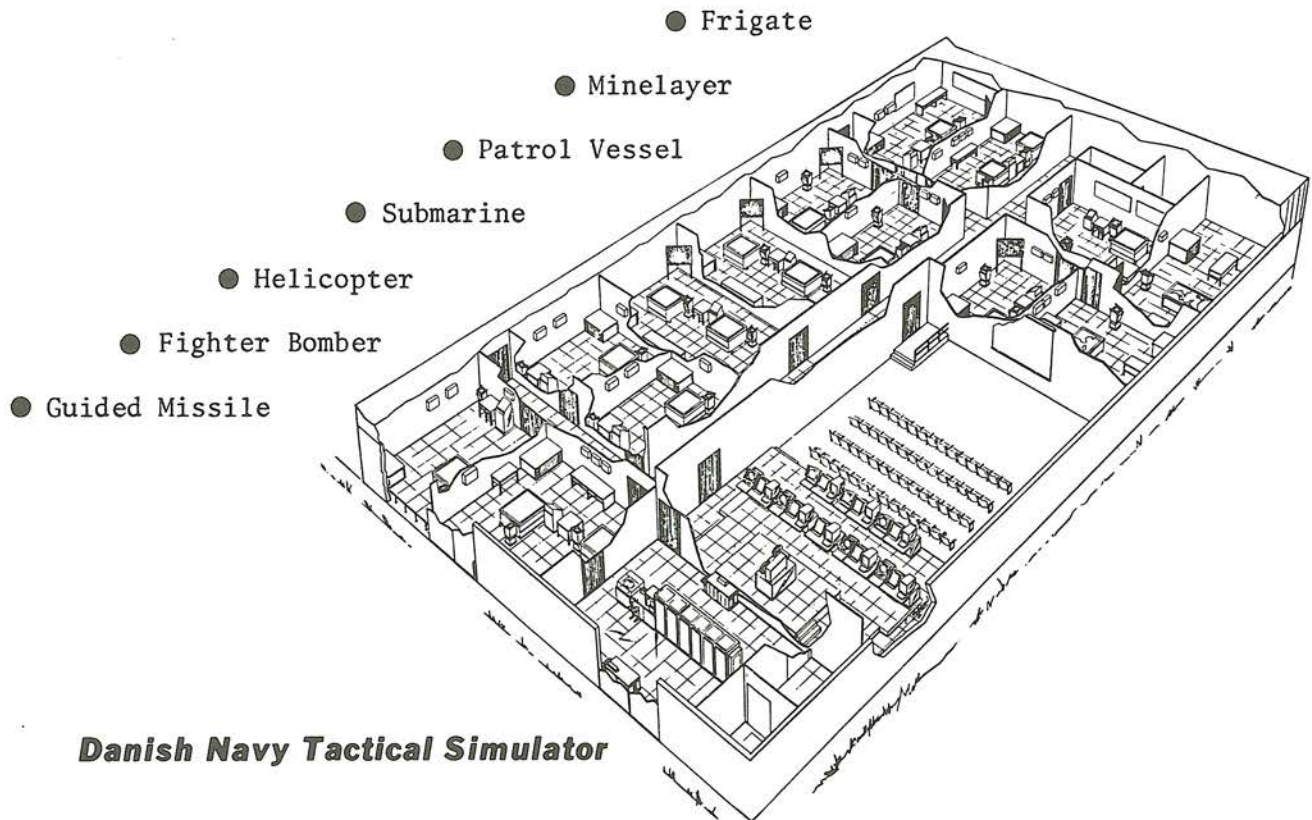

# General Aviation Trainers

Because of the tremendous growth of general aviation in recent years, the Simulation Products Division applied the technology and experience that produced sophisticated military trainers and space simulators to develop an effective contact and instrument flight trainer that was economical enough to be purchased by private flying clubs and schools, colleges, and even high schools.

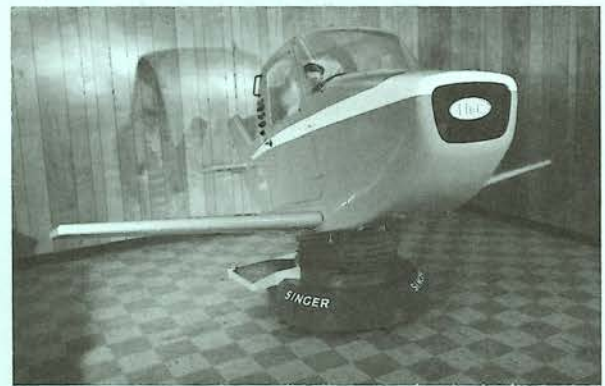

## **The GAT-1**

The first of what has become the GAT family was the GAT-1, which reproduces the characteristics of a single-engine, light, propeller-driven aircraft, using a three-degree-of-freedom motion system, a solid-state flight computer, realistic sound simulation systems, and a full complement of flight and engine instruments.

The GAT-1 is complete with 100% solid-state circuitry which incorporates the latest techniques in micro-circuitry and simple, trouble-free mechanical parts. It is fully equipped to provide instruction in contact maneuvers such as takeoffs, stalls, traffic pattern flying and landings, as well as instruction in radio navigation, instrument approaches, and communications. The automatic radio aids permits solo instrument practice. A sophisticated, solid-state flight computer, realistic sound simulation systems, and a full complement of operational flight and engine instruments are also basic to the GAT-1.



**the GAT-1 Trainer**



**GAT-1 assembly area**

# **Twin-Reciprocating-Engine Trainers**

Acceptance of the GAT-1 by the aviation industry as an effective flight training tool led to development of the twin-reciprocating-engine trainer. Capitalizing on the highly reliable hardware and sophisticated simulation techniques of the general aviation trainer, a trainer was developed that can be readily configured to simulate such aircraft as the Aztec, Beech 18, Cessna 310, Baron, and others. The trainer can be used in a variety of training programs such as:

- Multi-engine familiarization and handling
- Navigation and communications procedures
- Instrument approaches
- Basic instruments
- Emergency procedures.

Conventional gyros, instruments, and radios are standard equipment, while a wide variety of options may be selected.

The trainer operates in the following modes:

- Solo - Trainee in the left seat
- Dual - Instructor in the right seat
- Dual - Instructor in the jumpseat (remote instructor station option is not selected)
- Remote - Instructor at external console (remote instructor station option is selected)
- Multiple Training - Instructor monitoring instructor consoles of more than one trainer from central point (remote stations are selected)

Further, the instructor can freeze position and altitude, reposition, insert variables, or induce malfunctions from the control panel.

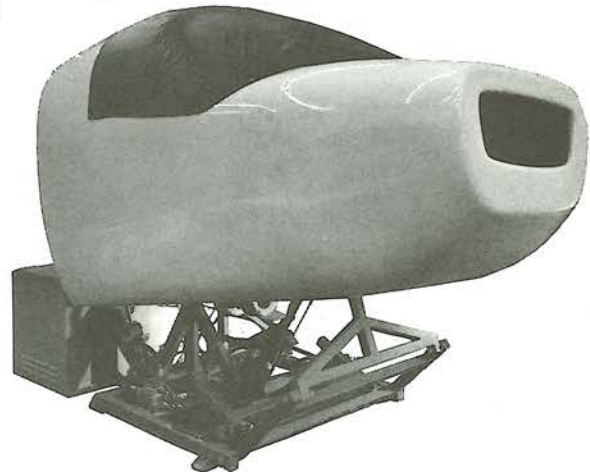

**cockpit and motion system**

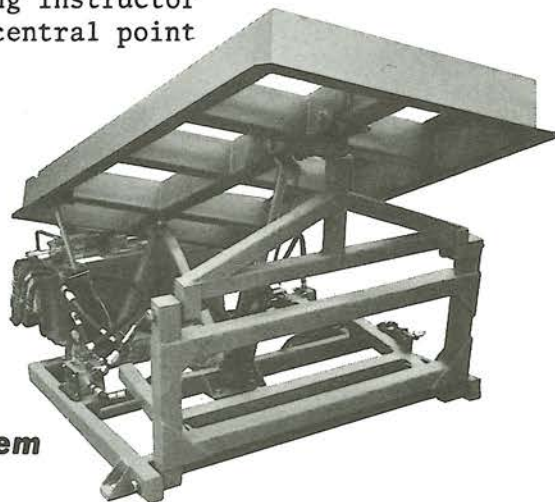

**motion system**

### **cockpit and motion system**



**Ground Path Recorder**

## **Twin-Jet-Engine Trainers**

The twin-jet-engine trainer provides the same training features and operational modes as the reciprocating engine trainer except that it represents a jet engine aircraft and, thus, enables jet aircraft familiarization and transition. In its basic configuration, it consists of a cockpit shell containing a facsimile of the pilot and copilot stations for a typical, twin-engine, utility class jet-powered aircraft.

Because this trainer makes fullest application of the modular construction concept common to all general aviation trainers, a host of specific buyer requirements can be satisfied. For example, in the business or utility class jet and turboprop field, the trainer can be configured to simulate such aircraft as the Lear Jet, Sabreliner, Falcon, Citation, Corvette, King Air, and others. In the commercial aircraft category, trainers can be provided for the DC-9, 737, BAC-111, A-300B, FH-227, etc. Finally, fighter aircraft such as the F-5 and A-4 can be simulated. Obviously, the twin-jet-engine simulator is a versatile training tool.

## **Helicopter Operational Trainer (HOT)**

The newest member of the GAT family, HOT, is intended to fill a critical need for low-cost helicopter training. The overall concept was to provide a training system that could be adapted to suit a variety of applications by addition of separately procurable modular elements tailored to meet particular training requirements. The training requirements encompass adaptability screening and preflight training, basic flight training and procedures, instrument flight, and radio/navigation practices, as well as proficiency (recurring) training. The HOT provides a training medium free from the limitations of the real-world environment, but with all the vital functions considered essential to a helicopter training program.

The HOT system, in its basic configuration, consists of a cockpit, a simulation computer (installed behind the cockpit), and a motion system, and makes fullest use of GAT systems and techniques. The instructor rides in the cockpit as he would in an operational helicopter. Optional modular elements that extend the training capabilities of the basic system include, but are not limited to: a radio aids package consisting of NAV/COM equipment panels and instruments, radio aids simulation printed circuit cards, and a flight path recorder; a group of additional flight instruments, a remote instructor station; a relative motion display system; and support services. The basic HOT system provides training in the skills required to control a single-rotor helicopter during take-off, hovering flight, transition to and from hovering flight, and landing.

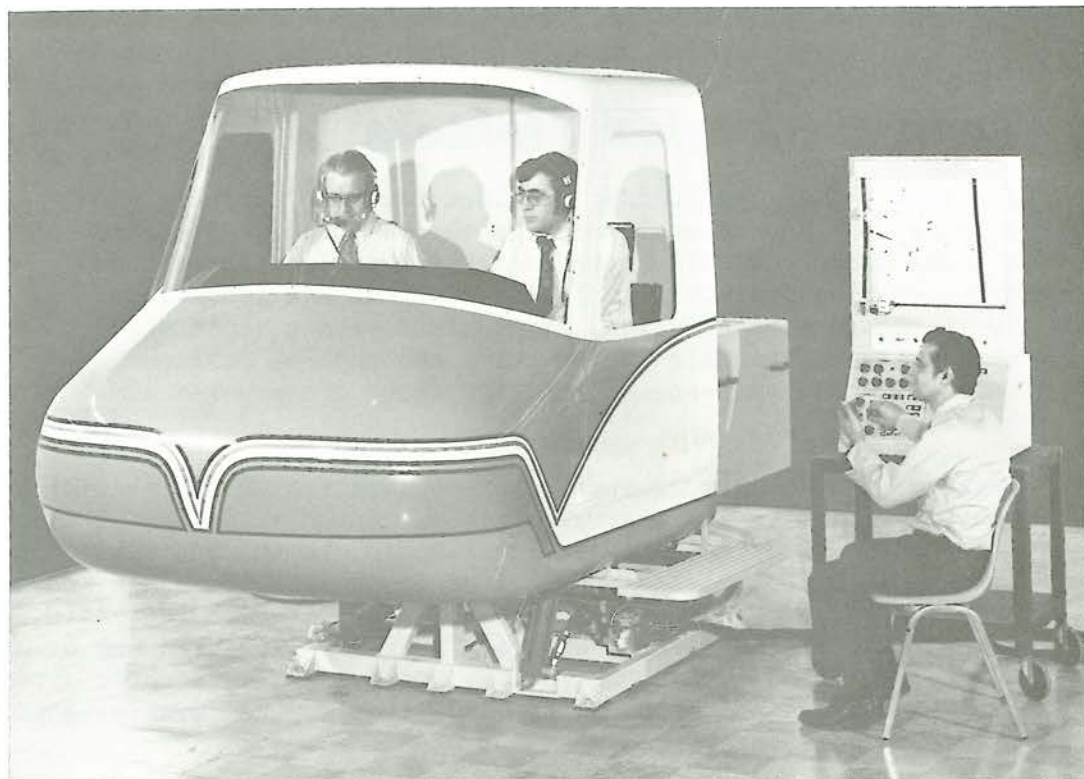

# Simulation Systems and Techniques

LINK trainers have achieved an enviable reputation in the simulation marketplace. One principal factor that has influenced this position is that the Simulation Products Division is continually pushing the state of the art to new levels and, in the process, has established an off-the-shelf inventory of hardware, software, and simulation techniques applicable to most new device requirements. Thus, while original design is necessary to ensure that a trainer for a new aircraft configuration performs correctly, it is very likely that such items as the motion system, computer complex, radar landmass system, advanced training techniques, visual system, and even some of the computer programs will be previously developed, highly reliable simulation systems. It is this practice that has made the LINK trainer a cost-effective device, and has secured its place in the forefront of simulation. Only some of the better known systems are described and illustrated herein.



## **Computer Technology**

In 1960, the Singer Simulation Products Division foresaw the advantages inherent in conversion from analog to digital simulation. At that time, no commercially available digital computer with sufficient memory capacity, operating speed, and input/output flexibility for real-time execution of simulation software was cost-effective enough for simulator application. To correct this deficiency, Singer developed the Mark I, the first practical, all-purpose, digital computer, and the forerunner of the Singer family of digital simulation computers.

## ***Singer-Designed Computers***

The Singer decision in 1960 to develop a digital computer was specifically aimed at the real-time aircraft simulation problem. The Mark I, the first practical, all-digital, simulation computer, was the result, and it was utilized on a number of commercial and military simulators. The Mark I was closely followed by further Singer-designed computers. The GP-4, which evolved in 1965 when the need arose for a computer capable of supporting a dual simulator complex, rapidly became known as the most versatile extant simulation computer, and supplanted almost all others. A natural outgrowth of a later need for increased computational speed resulted in development of the GP-4B, which was subsequently selected by General Dynamics and the Air Force for the F-111D Mission Simulator.

<u>COMPUTER</u>	<u>DESCRIPTION</u>	<u>APPLICATIONS</u>
Mark I	First special-purpose digital computer for real-time simulation	<b>7 B727's for Commercial Airlines</b> <b>2 C-135B's and 6 C-141's for USAF</b> <b>Dynamic Operator Research Apparatus (DORA) for General Dynamics</b> <b>2 Gemini Space Flight Trainers for McDonnell-Aircraft</b>
Mark II	Improved version of Mark I	<b>Edwards Air Force Base Space Flight Trainer</b> <b>R&amp;D Aircraft Trainer for USAF Wright Air Development Center</b>
GP-4	High-speed, solid-state parallel-binary digital computer employing DC level logic, magnetic drum memory for program storage, and magnetic core memory for data storage. First digital computer to enable driving 2 flight simulators from one computer	<b>13 Dual Installations to Various Commercial Airlines</b> <b>Over 25 single Commercial Airline Trainers</b>
GP-4B	Physically interchangeable and program-compatible with GP-4, but has second DMA channel and operates at 1½ times GP-4 speed.	<b>2 B747, 3 L-1011, and 3 DC-10 Commercial Simulators</b> <b>5 F-111D WST's for General Dynamics</b> <b>2 AJ-37 WST's for Swedish Air Force</b> <b>Nuclear Reactor Simulators</b> <b>F-4E, F-4J, F-4F</b>

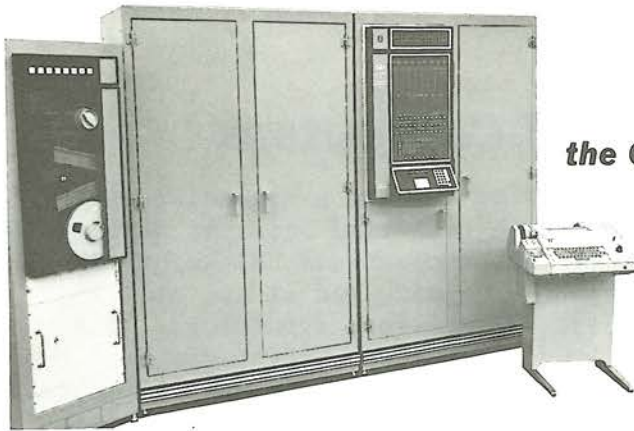

***the GP-4 Simulation Computer***



***the Sigma 5 Computer***

***the DEC PDP-11 Computer***



## ***Singer Data Center***

Located within a recently expanded Wayne, New Jersey computer complex facility, the Singer Data Center serves as a centralized data processing complex, filling the specialized needs of engineering and administration for the many Operations of Singer-Simulation Products Division. The Center's sophisticated equipment complement presently includes, or soon will include, IBM 370/165, SEL-86, Sigma 5, GP-4, GP-4B, and PDP-11 computers. Tied directly to the Center through a high-speed telephone communication system, the Simulation Products Division Operations each boast advanced associated support equipment and personnel qualified in comprehensive utilization of the facility. Thus, in addition to locally available computers, each Operation has a number of conveniently located input terminals that are always accessible to engineers and scientists for the solution of their simulation problems.

# Commercial Computers

Although Singer-designed simulation computers are versatile, the Simulation Products Division has continued to evaluate and use advanced developments by other digital computer manufacturers, and has employed a number of different devices in some training systems.

<u>COMPUTER</u>	<u>APPLICATION</u>	<u>CUSTOMER</u>
<b><u>HONEYWELL</u></b>		
DDP-24	2 Apollo Mission Simulators Video Film Converter	NASA NASA
DDP-124	9 Device 2B21 Automated Microfilm Aperture Card Updating System	NTDC U.S. Army
DDP-224	3 Apollo Mission Simulators 2 Lunar Module Simulators	NASA NASA
DDP-316	Maritime Training System Locomotive Simulator	Royal Danish Navy Santa Fe Railroad
DDP-516	2 Device 14B44 2 Device 14B40 3 2F87T 4 Optical Film Readers Collision Avoidance Radar Trainers Maritime Training System Danish Radar Trainer Device 2B24	NTDC NTDC NTDC U.S. Army USAF Royal Danish Navy Royal Danish Navy U.S. Army
<b><u>DIGITAL EQUIPMENT CORP.</u></b>		
PDP-11	S-3A WST B-727 C-130H RA5C	NTDC DLH Iran USAF
<b><u>RAYTHEON</u></b>		
703	5 FB-111 2 F-111D	USAF USAF
706	3 AJ-37 WST	Swedish Air Force
<b><u>XEROX DATA SYSTEMS</u></b>		
Sigma 5	9 FB-111 5 B747 Simulation & Training Media Development System	USAF AAL, NWA, TWA, UAL, SAA USAF
<b><u>SYSTEMS ENGINEERING LABS</u></b>		
Systems 86	Advanced Simulator for Undergraduate Pilot Training	USAF
<b><u>VARIAN ASSOCIATES</u></b>		
620 i	Device 2B24	NTDC

## ***Motion Systems***

Motion cue generation has been a vital aspect of flight training ever since the early LINK trainers first incorporated a bellows-type motion system. Over the years, Singer has developed several highly effective motion systems of various degrees of complexity to meet different vehicle or operator requirements. The simplest type is the stick shaker system in which a buffet signal is fed into the control loading system to give the pilot a realistic buffet effect. A second type, known as a seat shaker system, imparts motion to the pilot's seat with a hydraulic actuator controlled by a computer through a hydraulic servo valve. The seat shaker is normally used when the cockpit is not subjected to motion. More sophisticated cockpit motion systems which have been developed by Singer in recent years include the cradle system, the two-degree-of-freedom system, the three-degree-of-freedom system, and the five-degree-of-freedom system. The demands for more realistic simulation has resulted in a "state-of-the-art" six-degree-of-freedom system. This advanced system has been designed, developed and is used in advanced military and commercial simulator systems.

## **Three-Degree-of-Freedom Motion System**

The standard three-degree-of-freedom motion system represents a major step forward in motion simulation. Using this system, the flight station is supported by three hydraulic actuators, each controlled by a four-way hydraulic servo valve. The latter, upon receiving the command signal from a computer, controls the direction and flow rate of hydraulic fluid to the actuators. Both position and rate feedback controls are used in the servo loop to ensure proper response without hunting. The limits of motion to be incorporated into the simulated



motion system are determined from data on the aircraft flight characteristics. The angular rotation in pitch is a steady-state attitude effect – e.g., the cockpit will not automatically return to level after initial movement. In case of angular rotation in roll, the cockpit is imperceptibly returned to the normal level position after a steady state has been reached. Emphasis is placed on rapid initial roll, pitch, and vertical accelerations. The three degree system has been employed on B-58, C-130, 707, 727, DC-8, and DC-9 flight simulators.

**727 Simulator on  
Three-Degree-of-Freedom System**

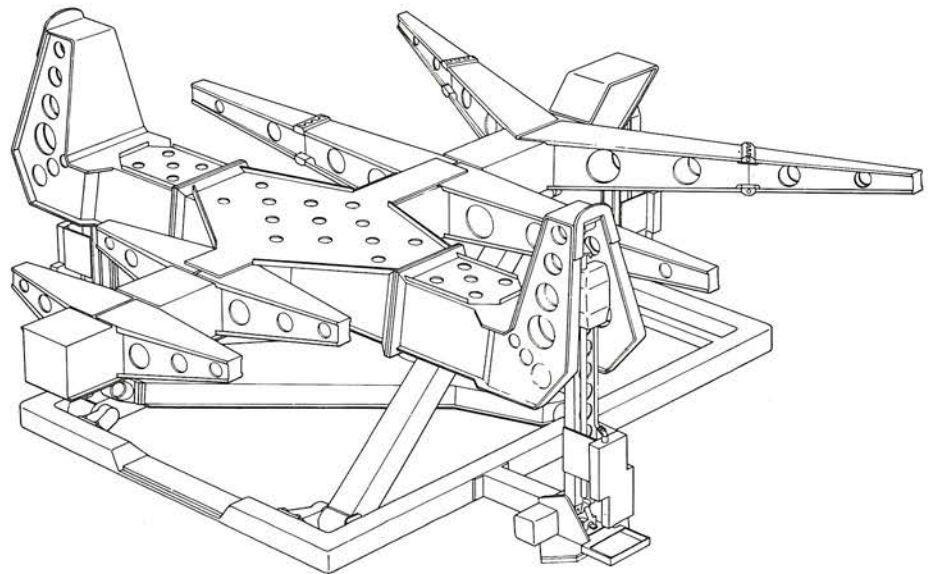

## **Cascaded Motion System**

Hydraulic servo actuators provide the basic three degrees of freedom – roll, pitch, and heave. The unique design permits selective increase via modular increments up to a full six degrees of freedom to meet specific customer requirements. The Singer Helicopter Flight Training System (HFTS) utilizes cascaded motion with five degrees of freedom; the F-4J is being delivered with a cascaded four degree of freedom motion system.

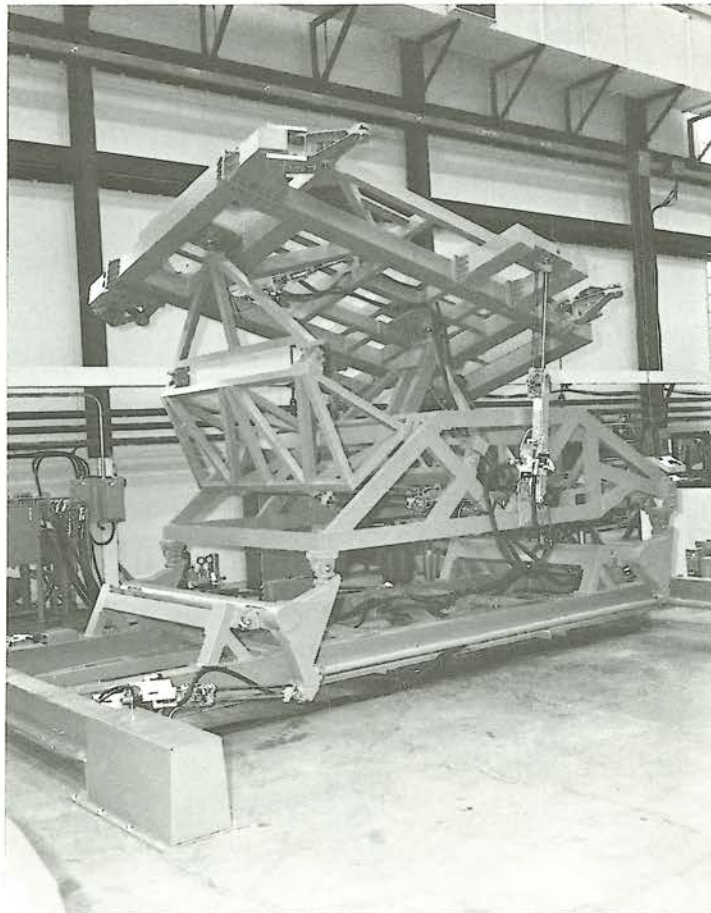

***Cascaded Motion System in extended position***

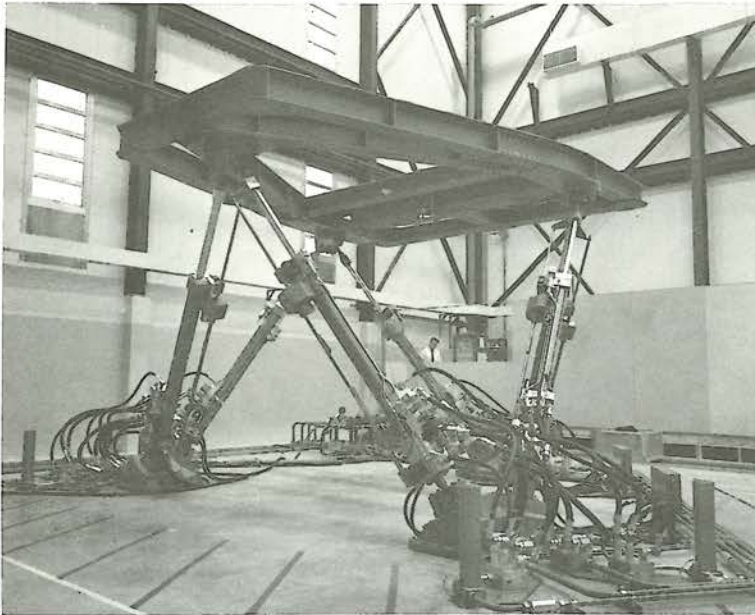

**Six-Degree-of-Freedom  
Motion System**

## **Six-Degree-of-Freedom Motion System**

The six-degree-of-freedom synergistic motion system is one of the most advanced in industry. Obvious advantages of this system include the attainment of longitudinal motion, additional cue capability, and associated improvement in overall simulation fidelity. The physical configuration of the system provides increased motion system excursion limits in all degrees of freedom. As a result of extended excursion, much greater latitude is available for optimum motion cue design. Cues can be maintained for longer periods, with subsequent washout at lower levels.

The system is currently incorporated in late generation commercial flight simulators - 747, L-1011, and DC-10 - and, because of its advanced training potential, has been purchased by the U.S. Air Force and NASA as an experimental training tool.

**Simulator on  
Six-Degree Motion System**







***... approach scenes with the VAMP\* system***

**\*Trademark of The Singer Company**

**Simulation Systems and Techniques**

## **Visual Systems**

The Singer Simulation Products Division has been producing visual display systems of varying types and complexities since 1942; among these is a visual system for takeoff and landing training that is used in conjunction with Douglas DC-10, Boeing 747, and Lockheed L-1011 simulators.

Perhaps more important than the visual systems already produced are those which are continually being studied to meet more complex requirements. It has been Singer's experience that as the demand for better visual systems increases, the design trend is toward more all-embracing systems in which the display more completely surrounds the trainee's position, where many of the restrictions on simulated maneuvers of the older systems are removed, and where compactness of the equipment and economy are prime goals.

The following discussion of visual systems relates some of the more interesting which have been studied and/or produced by The Singer Company. It also provides an indication of the diverse background which Singer has acquired in the development and production of optical equipment and visual display systems.

### **Earlier Visual Systems . . .**

#### **All Electronic Night Landing System**

The All-Electronic Night Landing System is used to train pilots in the proper approach and landing techniques necessary when visual cues are restricted to the landing techniques light pattern. The equipment uses a unique combination of analog and digital computer techniques to generate a runway landing light display on a television monitor screen.

#### **Day Night Visual System - SMK-23**

The SMK-23 provides pilot takeoff and landing training under varying aerological conditions which range from clear air and good visibility to instructor-selectable cloud cover, fog, and darkness. This visual attachment also provides training in aborted takeoff, waveoff, missed approach, go-around, and touch-and-go techniques.

#### **Airborne Fog Simulator**

The Airborne Fog Simulator developed for the Federal Aviation Research Development Service (ARDS) is used to evaluate lighting systems for runway approach and touchdown zones.

## ***Dynamic Operator Research Apparatus (DORA)***

The visual attachment for the Dynamic Operator Research Apparatus (DORA) reproduces, within certain limits, the visual terrain, weather, and cockpit windshield cues associated with vehicle flight.

## ***Edwards Space Flight Simulator T-27***

The T-27 portrays the real world as viewed from an orbiting space vehicle to teach spacecraft rendezvous and docking techniques. A single, reflective, three-input infinity image viewing system having a 110-degree horizontal by 80-degree vertical field of view and 12-inch exit pupil at the spacecraft window is utilized. The infinity image display system combines the direct view of a celestial sphere, the film projection of the earth scene from a Mission Effects Projector (MEP), and the closed circuit television input of the rendezvous (Agena) vehicle. An image of the rendezvous vehicle is generated by a television camera viewing a scale model of the target vehicle.

## ***Visual Space Simulation for Rendezvous Missions***

The Visual Space Simulator for Rendezvous Missions at Wright-Patterson Air Force Base provides the spacecraft with views of a rendezvousing space vehicle approaching at relatively uniform deceleration.

## ***Tactical Avionics System Simulator***

The Tactical Avionics System Simulator (TASS) provides all necessary cues to the pilot and gunner of a helicopter throughout both IFR and VFR operation in a tactical environment. This is achieved by the use of two identical model terrains, two TV cameras, two cockpit displays and associated electronic equipment.

## ***Command Module Simulator Window Displays***

The visual system for the Command Module Simulator presents to the astronauts within the simulated command module realistic scenes of the external environment during the total lunar mission. These scenes are simulated for the two landing windows and the two rendezvous windows of the Apollo Command Module.

Image generation and display equipment displays the following visual scenes as they appear under actual mission conditions:

- Stars to the fifth magnitude
- Orbital and distant earth scenes
- Orbital and distant moon scenes
- Sun shafting
- Rendezvous and docking with the LEM vehicle

## ***CMS Telescope and Sextant***

The functions of the on-board telescope and sextant of the Apollo Command Module are simulated in the Command Module Simulator. The telescope and sextant are used for navigational purposes and may be operated manually or in conjunction with the on-board Guidance and Navigation Computer. The measurements made with these instruments are used to determine and verify flight path, range, and altitude in order that corrective signals may be applied to the flight control systems.

## ***High-Speed, Low-Level System***

The high-speed, low-level image generator computes correct video information on a point-by-point basis using stored landscape or luminance data from one transparency and terrain elevation data from a second transparency. It provides a visual area of 200 by 200 miles with a maximum visibility of ten miles and accommodates altitude variations of from 200 to 3,000 feet.

## **State-of-the-Art Visual Systems**

### **Variable Anamorphic Motion Picture (VAMP) System**

Responding to the demand for exacting visual fidelity with infinity-imagined screen displays and real-world perspective, Singer developed the Vamp visual system. Based upon the use of 70 mm color film made by a camera "flown" along ideal airfield approach and landing paths, Vamp provides an ultra-high-resolution, high-brightness color picture of real-world imagery to the trainee. Through the use of special perspective transformation optical elements operating under computer control, means are provided for deviating from the "filmed" flight path through a substantial flight envelope. The image presented reflects the instantaneous position and attitude of the simulated aircraft as it is flown through approach, landing, and take-off maneuvers, and flight above clouds.

Advantages of the Vamp include an actual approach to any desired airport; any combination of weather, ceiling, and visibility effects induced through special effects photography; ease of maintenance; and high reliability.

Verification of the Vamp system's performance excellence is evidenced by the number of customers, both commercial and military, who have purchased the system, the number who have subsequently re-ordered Vamp when contracting for additional simulators, and the variety of simulators with which it is employed.

**simulator with VAMP enclosure . .**

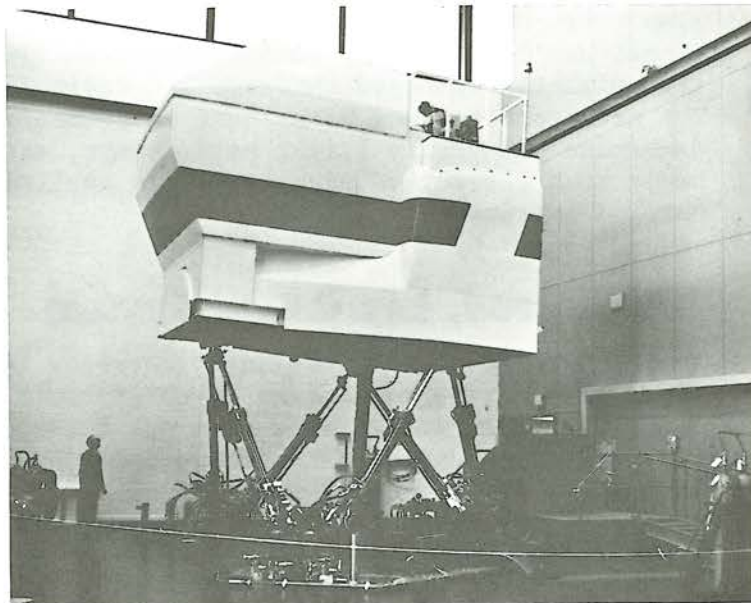

## ***Command Module Simulator Window Displays***

The visual system for the Command Module Simulator presents to the astronauts within the simulated command module realistic scenes of the external environment during the total lunar mission. These scenes are simulated for the two landing windows and the two rendezvous windows of the Apollo Command Module.

Image generation and display equipment displays the following visual scenes as they appear under actual mission conditions:

- Stars to the fifth magnitude
- Orbital and distant earth scenes
- Orbital and distant moon scenes
- Sun shafting
- Rendezvous and docking with the LEM vehicle

## ***CMS Telescope and Sextant***

The functions of the on-board telescope and sextant of the Apollo Command Module are simulated in the Command Module Simulator. The telescope and sextant are used for navigational purposes and may be operated manually or in conjunction with the on-board Guidance and Navigation Computer. The measurements made with these instruments are used to determine and verify flight path, range, and altitude in order that corrective signals may be applied to the flight control systems.

## ***High-Speed, Low-Level System***

The high-speed, low-level image generator computes correct video information on a point-by-point basis using stored landscape or luminance data from one transparency and terrain elevation data from a second transparency. It provides a visual area of 200 by 200 miles with a maximum visibility of ten miles and accommodates altitude variations of from 200 to 3,000 feet.

## **State-of-the-Art Visual Systems**

### **Variable Anamorphic Motion Picture [VAMP] System**

Responding to the demand for exacting visual fidelity with infinity-imaged screen displays and real-world perspective, Singer developed the Vamp visual system. Based upon the use of 70 mm color film made by a camera "flown" along ideal airfield approach and landing paths, Vamp provides an ultra-high-resolution, high-brightness color picture of real-world imagery to the trainee. Through the use of special perspective transformation optical elements operating under computer control, means are provided for deviating from the "filmed" flight path through a substantial flight envelope. The image presented reflects the instantaneous position and attitude of the simulated aircraft as it is flown through approach, landing, and take-off maneuvers, and flight above clouds.

Advantages of the Vamp include an actual approach to any desired airport; any combination of weather, ceiling, and visibility effects induced through special effects photography; ease of maintenance; and high reliability.

Verification of the Vamp system's performance excellence is evidenced by the number of customers, both commercial and military, who have purchased the system, the number who have subsequently re-ordered Vamp when contracting for additional simulators, and the variety of simulators with which it is employed.

**simulator with VAMP enclosure . .**

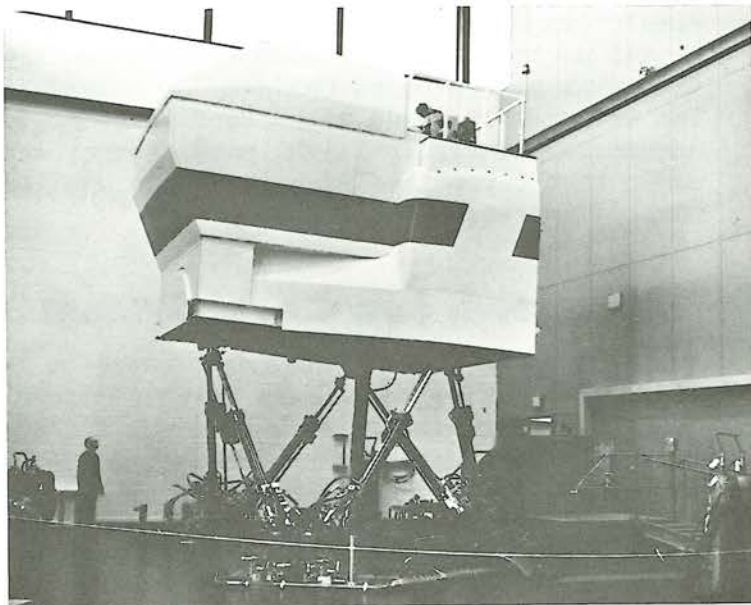

## ***Area of Interest Visual System***

Singer developed an Area of Interest (AOI) Visual System in cooperation with the Air Force under Government contract. The system derives its name from the concept of an "area of interest" which commands a pilot's attention during a maneuver. This area of interest (AOI) is centered about a point of interest, typically an air or ground target, during weapon delivery maneuvers. Based on nominal mission profiles extracted from training handbooks, the migration of the area of interest around a cockpit-oriented frame of reference during the course of a mission defines the field of view required to maintain the area of interest always within sight, and thus dictates the field of view required in a visual system used to train for these maneuvers.

The AOI concept was subsequently used to define a visual system that provides the features considered necessary for tactical fighter training. These features include the following:

- A display system with a field of view large enough to contain the area of interest for most of the commonly used training profiles.
- High resolution and a high degree of realism for imagery contained within the area of interest.
- The capability for moving the area of interest anywhere within the display system field of view, as a function of pilot maneuvers relative to the fixed target point.
- Peripheral imagery of comparatively low resolution and realism in that portion of the display field of view unfilled by the area of interest.
- Incorporation of true perspective and motion effects into both the area of interest and the peripheral imagery.
- Large simulator excursion envelope capability.



## MARK V Visual System

The Mark V Visual System utilizes the principle of viewing a rigid three-dimensional scale model by a closed-circuit television system. The model depicts an airfield with Category II lighting and surrounding terrain. The television camera is positioned over it in a location corresponding to that of the simulated aircraft, and is moved at scaled aircraft rates and accelerations. The television camera with its associated optical probe is mounted on a vertical carriage gantry that is servo-driven in two translational dimensions and in the simulated altitude dimension. The attitude of the simulated aircraft is duplicated by elements within the optical probe.

The optical probe projects an image of the model directly ahead of the simulated aircraft onto the photocathode of the television camera. The final display is provided to both the pilot and the first officer by a dual-collimating optical viewing head. The full color display includes the runway approach and edge lights, airport facilities, and surrounding terrain. Lighting on the model is variable to simulate various ambient lighting conditions from full daylight to full night.

The model assembly is a rigid three-dimensional scale model of the airport complex and surrounding terrain. The airport complex includes buildings, taxiways and ramps, and a runway 11,000 feet along with Category II lighting and markings. The airport

lighting includes all the necessary approach, strobe, runway, and taxiway lighting in addition to the visual approach slope indicator (VASI) system. In addition to the lighted runway, there is also an unlighted runway at least 8,000 feet long that contains its own VASI system. The area surrounding the airfield represents a typical countryside, including roadways, vegetation, open fields, and scattered housing and other buildings.

By electronically altering the terrain image, a TV video system affords great flexibility in terms of the special effects that may be generated for visibility and ceiling. The realism of the display of the pictorial information stored in the model is significantly improved by introducing visual effects such as clouds, haze, and fog.

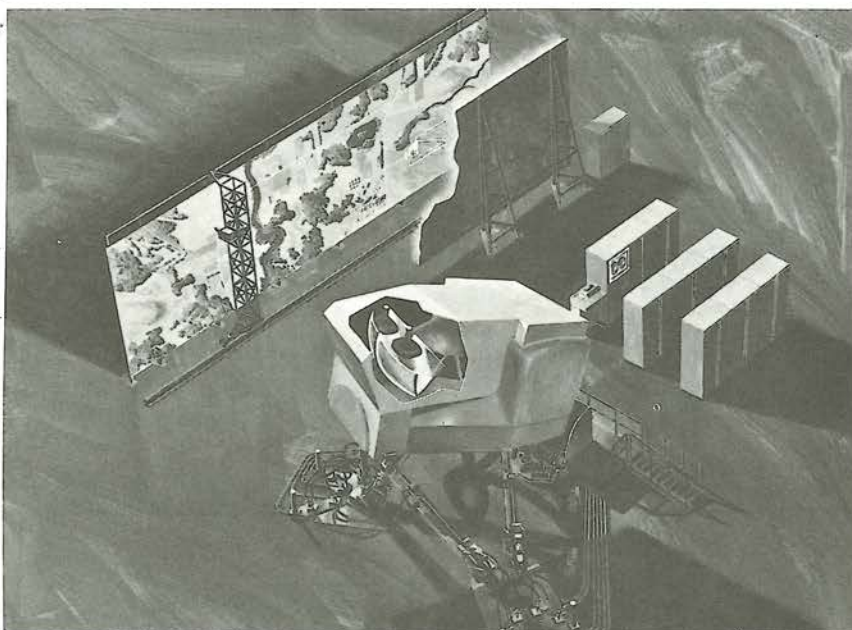

# SCAMP (Scanned Motion Picture) Visual System

The SCAMP visual system incorporates electronic perspective transformation; it is an all-electronic version of the larger Vamp system which uses 70 mm color-film made by a camera "flown" along an ideal approach and landing path to an airfield. The SCAMP visual system is functionally identical to the Vamp visual system, except that it uses 35 mm film scanned by a flying-spot scanner, with television as the display medium rather than direct optical film projection, and the required perspective distortion is accomplished through electronic computation rather than through optical distortion elements. This results in a dramatic cost reduction for the overall system. The only performance sacrifice which accompanies this cost reduction occurs in resolution. The very high picture quality of the optical Vamp system (2-3 arc minute resolution) is reduced, through the use of commercial color television, to approximately 10 arc-minute resolution, which is equivalent to the picture quality provided by commercial camera/model visual simulation systems employing color television. However, camera/model systems cannot provide a constant picture quality for all altitudes since they suffer from optical defocussing at low simulated altitudes. By contrast, the SCAMP system provides constant resolution for any altitude equal to the best picture provided by color camera model systems at their most favorable altitudes.

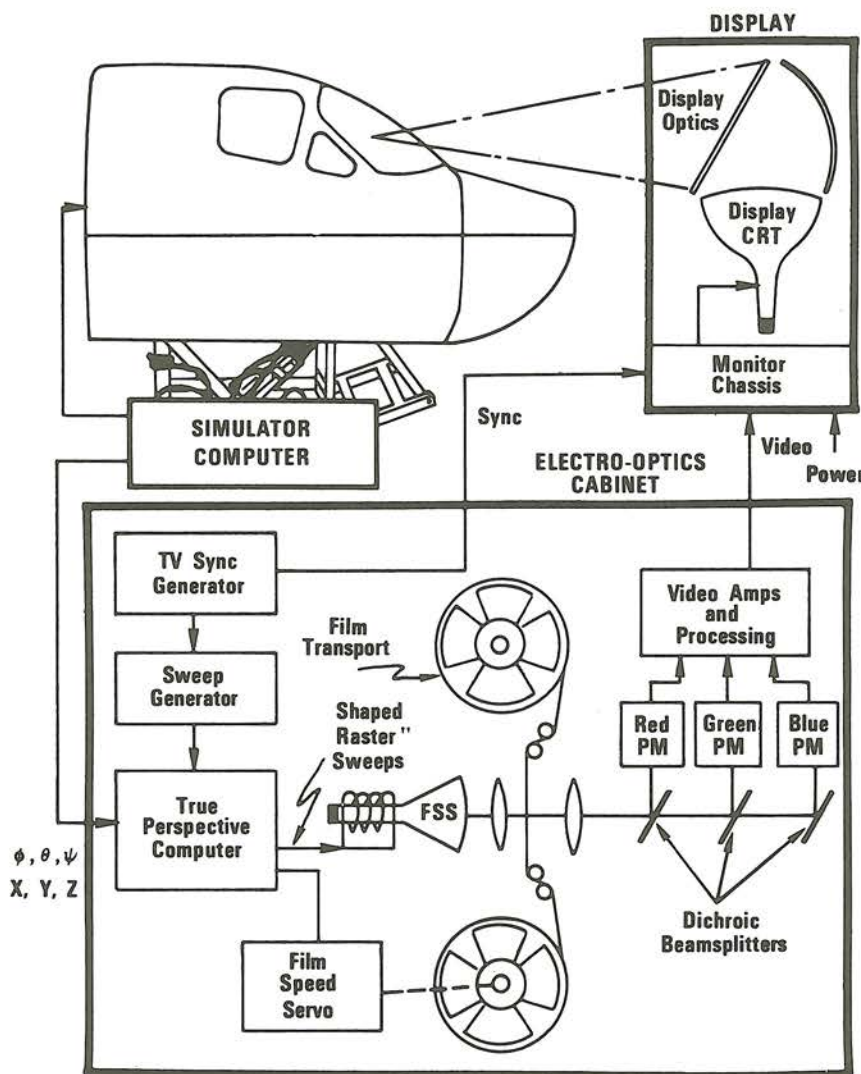

**SCAMP Schematic**

## **Computer Image Generation (CIG) Visual System**

Research and development of a digital Computer Image Generation (CIG) system has been an on-going program at Singer for several years. The accompanying photograph was taken directly from a CRT presentation used with the CIG.

The Singer CIG System is based upon extensive visual simulation development activity. Use of the extensive computer-controlled image processing facilities of the Singer Image Research Laboratory has been instrumental in achieving the systems essential to a practical and realistic CIG system.

The Singer goal in development of a digital image generation (DIG) system has been to develop a technique which provides minimum system complexity and maximum scene fidelity. Singer has carefully reviewed the manifold problems of visual system integration with the flight simulator, which is an area of experience unmatched in the industry.

In design of the Singer CIG system, an extensive engineering simulation was performed on a general-purpose computer which simulated all of the system hardware and provided assurance that development of a real-time system was feasible. Singer has designed and is currently building and testing key real-time hardware subsystems including the face boundary list processors, scanline computer, output buffer and special effects and video generator.

The Singer design includes elimination of unnecessary scene detail early in the computation cycle and performing scanline computation asynchronously with respect to the displayed image. These features have permitted logic speeds, resulting in system complexity and reliability advantages.

The implementation of the simulation program has enabled Singer to simulate a number of different conceptual and hardware approaches to system and subsystem design without having to commit to a particular design. This approach allows Singer to trade off a variety of system concepts and approaches to configure a design fully responsive to and consistent with current and future visual simulation requirements.



**computer generated T-37 Aircraft image**

## **Radar Landmass Systems**

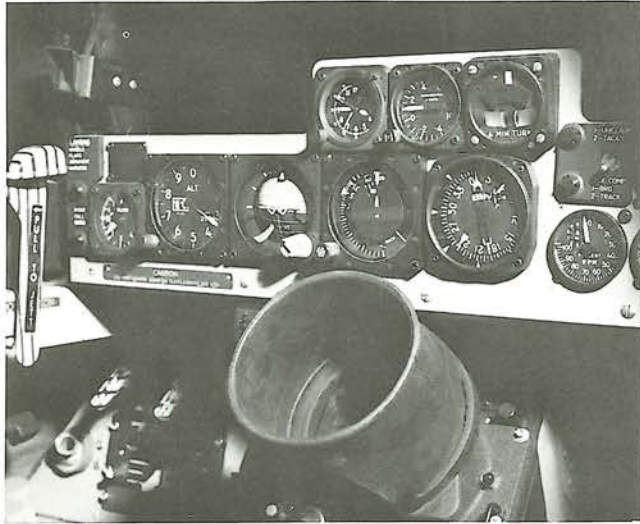

**F-4 Radar Observer's Station**

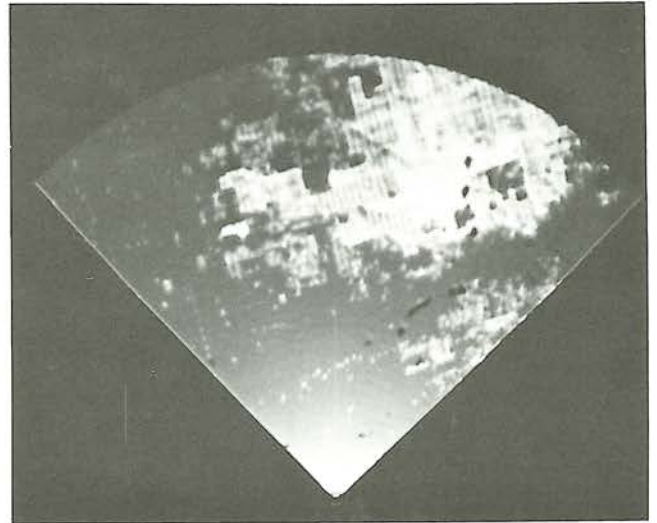

**Typical Radar Presentation**

## **Analog Radar Landmass System**

The Singer Simulation Products Division's analog RLMS has long been recognized as an important feature of military weapon system trainers, as evidenced by the accompanying list of current contract experience. The Division's Advanced Products Operations currently holds six approved design patents with a number of others pending. The analog RLMS realistically simulates radar ground and sea returns, and features an accumulation of standard and unique design concepts that are the result of design evolution from such programs as the F-4, A-7, F-111, and others.

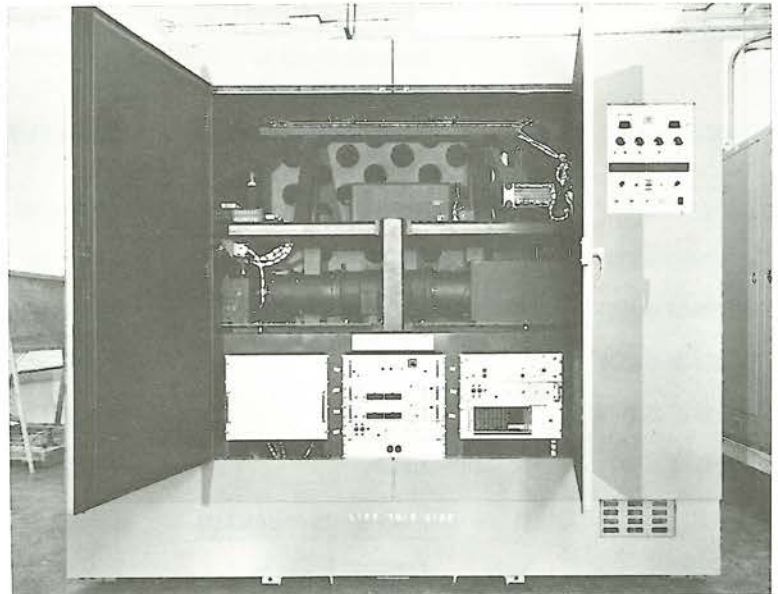

**F-111 RLMS Optics Cabinet**

# Digital Radar Landmass System

DRLMS development activity at Singer has culminated in a system approach, the feasibility of which has been proven by computer simulation, by construction and demonstration testing of a real-time laboratory model and, finally, by receipt of a contract from Grumman for the first Singer DRLMS for the E-2C Trainer. The DRLMS is a digital image generator which generates radar imagery by real time digital computation.

The intensity of brightness of each element of the simulated radar image (i.e., the radar power return) is determined by the composite of many individual influences, among which are the effects of shadowing, range and atmospheric attenuation, earth curvature and refraction, receiver gain, antenna gain pattern, aspect angle, and far shore brightening.

## Analog and Digital RLMS Programs

<u>ANALOG RLMS PROGRAMS</u>		
<u>CONTRACT NO.</u>	<u>AGENCY</u>	<u>TITLE</u>
N61339-1711	NTEC	Device 2F84, A-7A
AF33(657)-8260	GD/FW	F-111A(prototype)
N61339-1520	NTEC	F-4C, F-4D, RF-4C
A49-52870	French Government	Cyrano RLMS
N61339-1783	NTEC	Device 15A18
P.O. 2-24481C (NAS9-1100)	Grumman A/C Corp. (NASA)	LEM
C.80.868	Standard Telephone et Radio SA (Swiss) Le Material Telephonique	Tarran Simulator
515 667	Royal Australian Air Force	Cyrano RLMS
N61339-1842	NTEC	F-4D(4), RF-4C(3)
AF33(657)-15427	USAF	F-111A(3)
N61339-66-C-0021	NTEC	A-7E follow-on
N61339-66-C-0090	NTEC	F-4E(15)
N61339-69-C-0174	NTEC	F-4J(2)
N61339-70-C-0125	NTEC	F-4E(2)
<u>DIGITAL RLMS PROGRAMS</u>		
P.O. 7-85504 (N00019-71-C-0450)	Grumman A/C Corp. (USN)	E-2C - First Digital landmass system
N61339-72-C-0046	German Air Force (per NTEC)	F-4F(4)

Real-time computation requirements for digital image generation and digital radar landmass simulation led to the development of high speed, flow-through arithmetic processors. The DRLMS employs these processors in a serial-parallel configuration which makes optimum use of simultaneous computation.

## **Training Studies**

Because simulators are basically advanced training devices, Singer has devoted a large portion of its research and development effort to improving and expanding training benefits. The advent of digital simulation uncovered new, more efficient techniques for improving the instructional function as well as enhancing and expediting the transfer of learning to the student. Several representative training studies are presented.

### **Undergraduate Pilot Training [UPT] System Study**

Under Air Force Contract F33615-70-C-1141 the Simulation Products Division teamed with Lockheed-California Company and System Development Corporation to identify the changes that will be required in the UPT program in the post-FY-1974 era. This study addresses the future pilot training program and the pilot training process from a total systems concept. The study consists of three phases of sequential activity:

- To identify and catalog the nature of the future undergraduate pilot training requirements, including future pilot skills, tasks, and roles.
- To derive alternative training systems embodying different concepts, technology, and training curricula.
- To conduct a comparative analysis of alternative training systems and recommend a preferred or optimum training system which embodies all sub-elements, equipments, curricula, techniques, concepts, and approaches, and develop a UPT system model and an integrated management subsystem to manage UPT resources.

### **Tactical Situation Requirements Study**

Internally-funded studies relating to the definition of task and skill requirements for flight crews involved in the use of tactical equipment resulted in the development of techniques defining requirements for trainee feedback, performance evaluation and recording routines. Computer programs were then developed, permitting the evaluation of these techniques during flight crew training sessions.

### **Study for Research in Automated Instruction and Performance Monitoring**

This research was conducted for the Air Force Human Resources Laboratory under Contract No. F33615-69-C-1159. The goals of this program, as related to automated instruction and performance monitoring, were to establish overall design approaches, develop programming techniques, establish computer memory and speed requirements through tradeoff studies, and define requirements for special peripheral equipment.

## ***Tracking Evaluation Study***

This study (Contract No. N61339-69-C-0207) was undertaken to determine the requirements for an experimental training facility. Personnel and skill requirements to be served by NTDC-procured training equipment were determined by systematic analysis of weapon systems and personnel projections. All major types of training systems which are now procured or may be procured in the future by NTDC were then analyzed to determine their relative importance, and commonalities among them. From this information, a determination and tentative selection of training systems was made.

## ***Commercial Airline Requirements Study***

A recent study contract helped define task and skill requirements for airline flight crews, and indicated the techniques required for developing crew skills in a flight simulator environment. Further in-house studies have developed techniques for defining maneuver demonstration, trainee feedback, performance measurement, and recording routines, and for programming routines in the simulator computer. Current efforts have been directed toward developing an advanced training package in which the development of crew skills is optimized by presenting maneuver demonstration and performance feedback to the trainee crew, by systematic control of the learning situation, by meaningful measurement of crew performance, and by the recording of data required for effective instructor evaluation. Performance measurement and recording are based on the definition of performance criterion ranges relevant to specific aircraft maneuver conditions, as determined in cooperation with experienced flight, flight training, and evaluation personnel.

# Industrial Simulators

The number and variety of applications for which simulation and training devices are practical and cost-effective continues to expand, particularly as industrial equipment becomes more sophisticated and as industrial labor and materials become increasingly more expensive. Only two of the more recent applications for LINK simulators as training devices are herein presented. Also, note that there are many other devices described in the section on Training Devices and Procedures which could be classed as Industrial Trainers. Industrial Trainers are so identified because they are full simulators, and are more sophisticated and complex than classroom and part-task trainers.



## **Railroad Simulators**

The Santa Fe Railway owns and operates the nation's first locomotive and train simulator as part of its engineman training program. The Singer-designed simulator is mounted in a railway car, allowing easy movement to all points on the Santa Fe, and realistically reproduces the sounds, sights, and movements of train operation without actually moving over the rails.

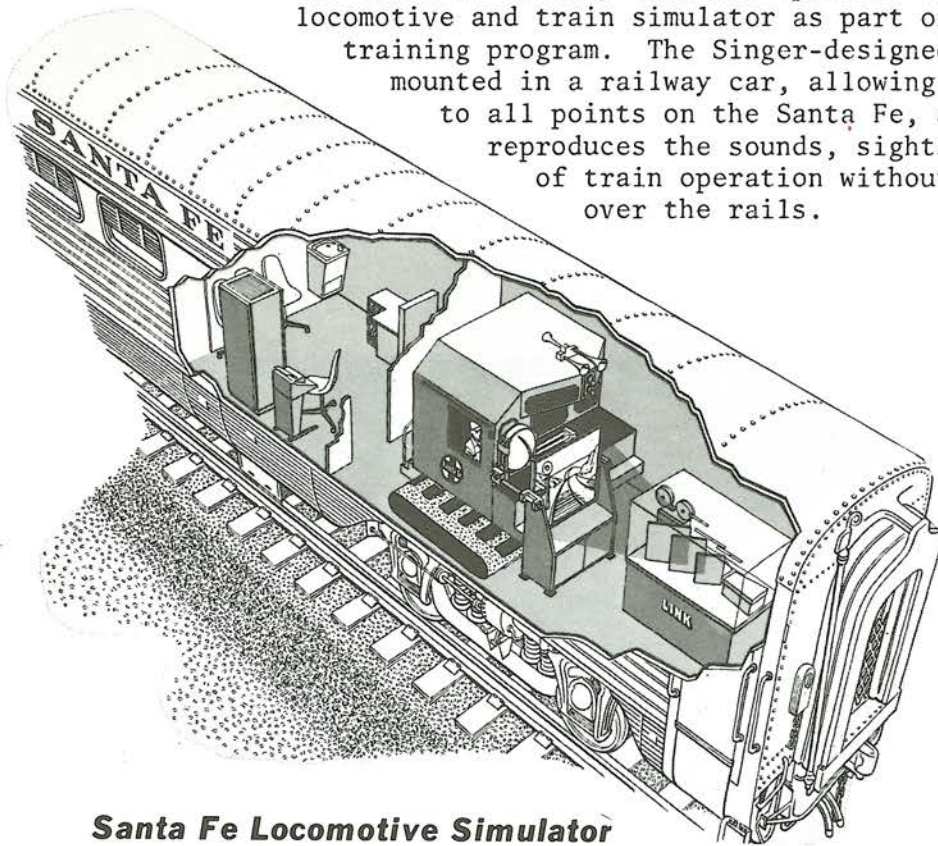

**Santa Fe Locomotive Simulator**



## ***Nuclear Power Plant Simulators***

Babcock & Wilcox, suppliers of power equipment, acquired the world's first full-scale pressurized water reactor plant simulator in 1970 when Singer installed it at their Nuclear Training Center, Lynchburg, Virginia. The simulator, an exact replica of a nuclear plant control room, uses a Singer GP-4B computer to simulate the dynamic performance of an actual plant in real time. A second nuclear power plant simulator was ordered for Combustion Engineering, Inc., of Windsor, Connecticut.



***Nuclear Power Plant Simulator in operation***

# Training Procedures and Devices

In addition to the fully computerized simulators described in previous sections, the Simulation Products Division also produces a wide variety of less complex, less expensive devices that nevertheless provide a training function. In most cases, the training function is limited or less demanding than in a full simulator. Singer trainers that fall into this category are:

- Flight and Driver Trainers
- Classroom System Trainers
- Mechanical Panel Trainers
- Part Task Trainers
- Universal Process Trainers
- Component Trainers
- Instrument Trainers
- Closed Loop Trainers
- Applied Principles Trainers
- Combustible Hazards Trainers
- Response System Trainers

While the above are designed primarily for air crew instruction, others are intended for industrial use in such areas as the chemical, petrochemical, and wood pulp industries.

## **Open-Face Cockpit Procedures Trainer (OFCPT)**

The OFCPT is designed for cockpit familiarization of flight crews transitioning to different aircraft and for recurrent training of other airmen. Trainees can practice both normal and emergency procedures, using control movement and pointing techniques coupled with instrument responses and oral explanations. The open nature of the cockpit, as opposed to the conventional closed cockpit shell, provides a ready means for group and classroom instruction.

## **Classroom Systems Trainers**

Classroom System Trainers are normally used for major aircraft systems - electrical, fuel, air conditioning, and hydraulic - but can also include combinations of systems such as fire, pressurization, anti-icing, and pneumatic. Classroom trainers of this type are backlighted with either gray or black face schematic diagrams. The gray face schematic is visible at all times, regardless of backlighting, and is used for instruction of the overall system before considering specific parts of the system. The schematic diagrams with black face are only visible when backlighted, and enable the instructor to discuss individual elements before describing the system as a whole.

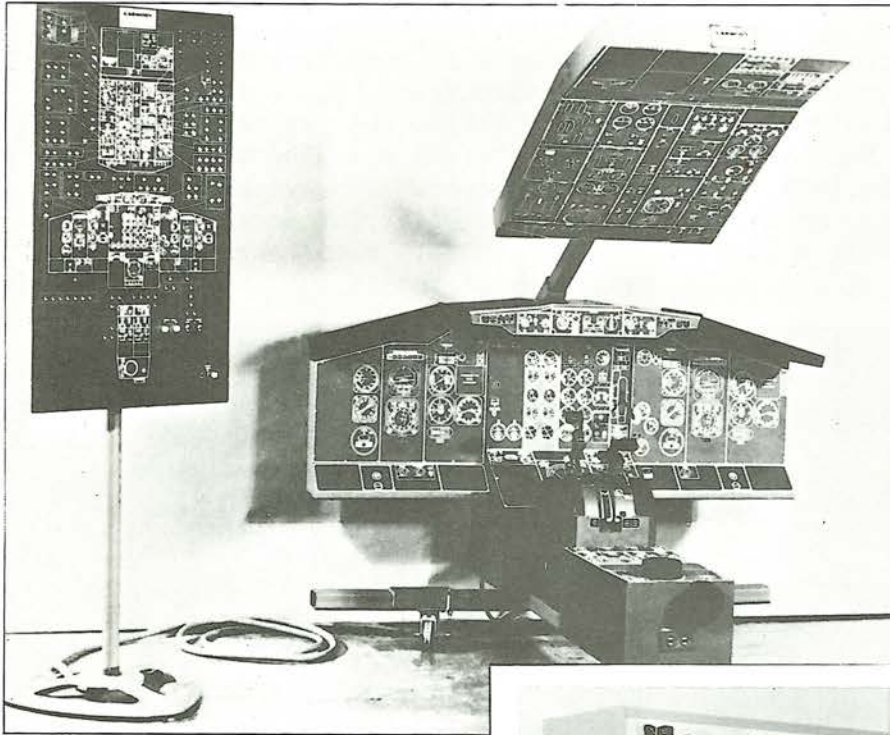

**the OFCPT**

**DC-9 Fuel System  
Classroom Trainer**

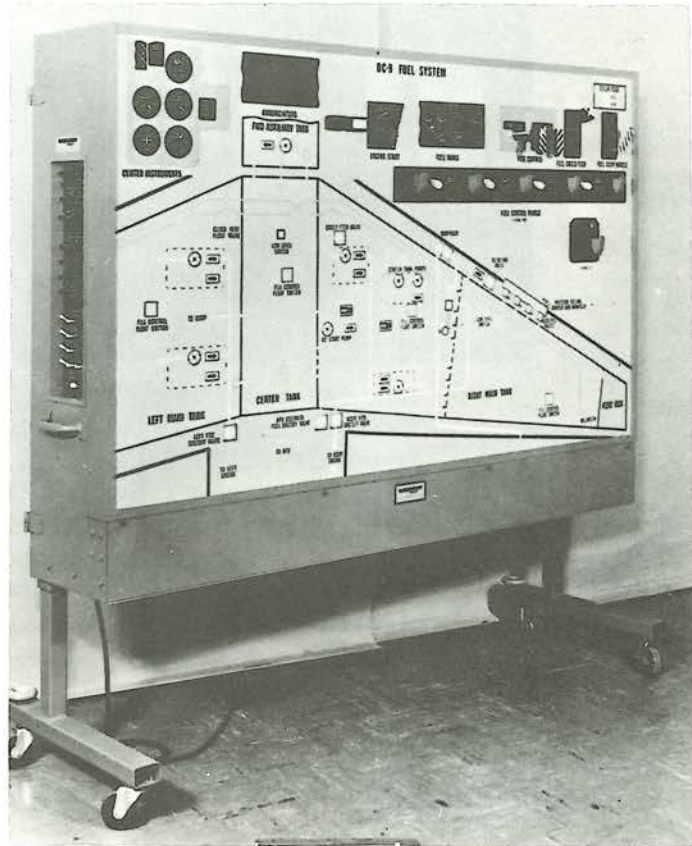

## ***Driving Simulation System***

The LINK Driving Simulator System, SS-6-S, is an instructional tool that enables the student to practice driving techniques in a variety of driving situations while monitoring a classroom environment. The system uses multiple units to enable an instructor to provide quality individual tutorial assistance. Many secondary school systems throughout the country have purchased the LINK Driver Trainer because it provides two important advantages: (1) it eliminates the possibility of accidents; and (2) it enables teaching a large number of students simultaneously, whereas only one student at a time can drive an automobile.

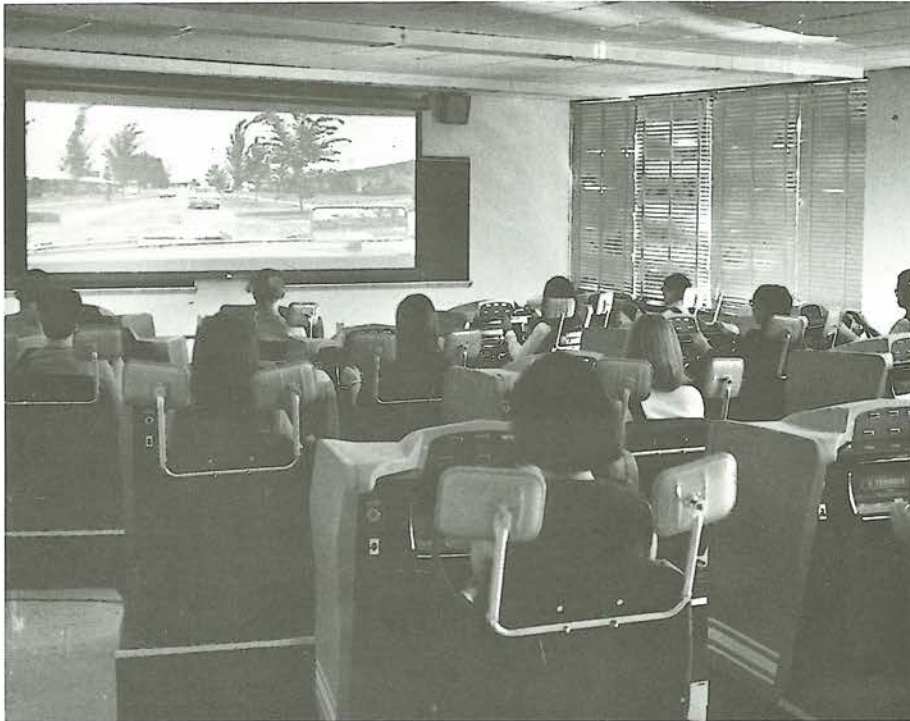

But the full scope of application of the Driving Simulator System has yet to be realized. For example, Iowa Central Community College under a federal grant made possible by the National Highway Safety Act recently placed an order for a classroom driver trainer for school bus drivers. An actual Blue Bird school bus is being outfitted to accommodate the Singer system. Other potential uses are also being reviewed.

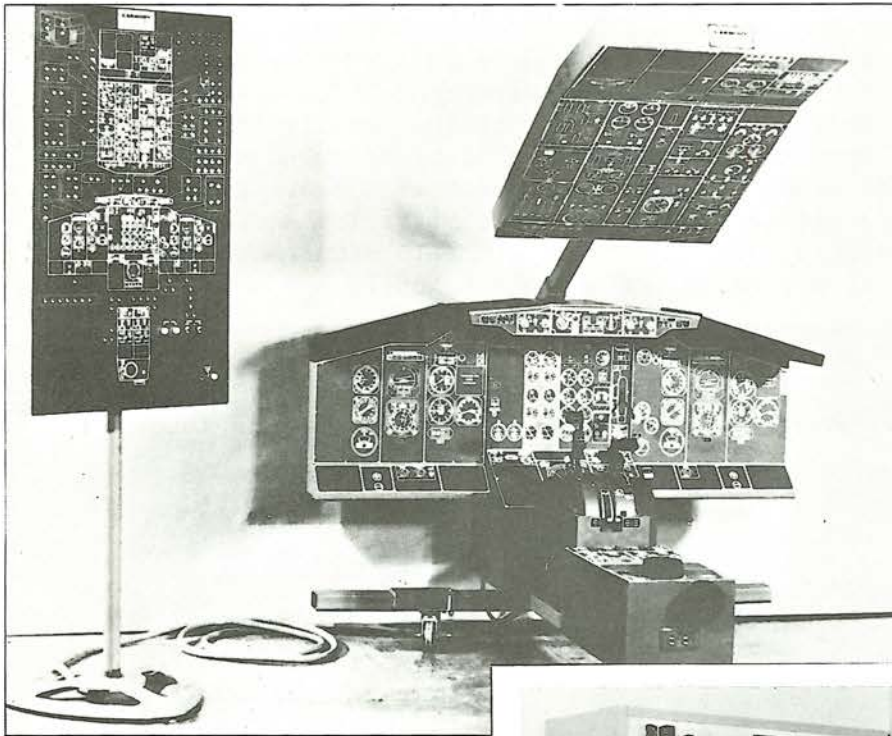

**the OFCPT**

**DC-9 Fuel System  
Classroom Trainer**

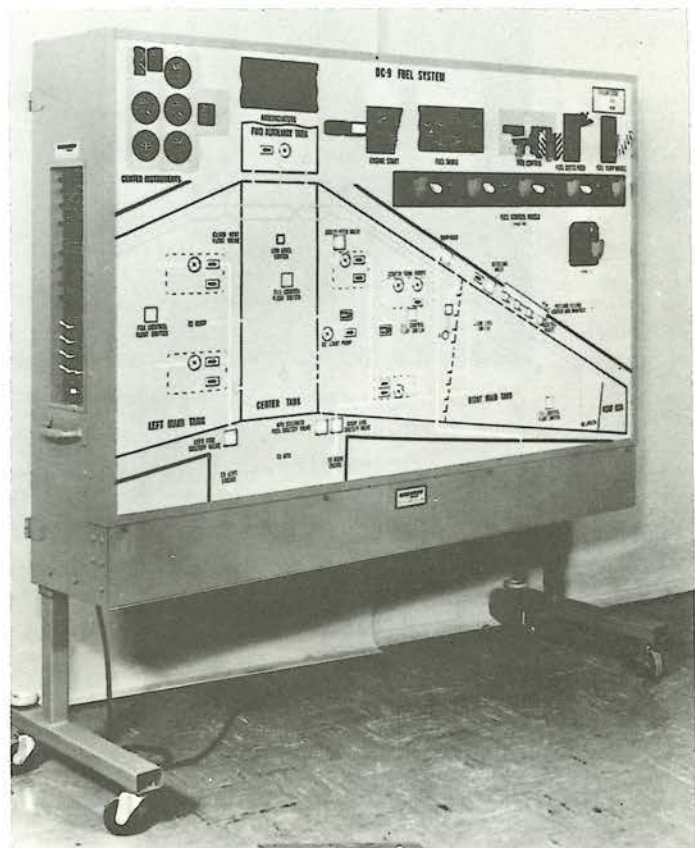

## ***Driving Simulation System***

The LINK Driving Simulator System, SS-6-S, is an instructional tool that enables the student to practice driving techniques in a variety of driving situations while monitoring a classroom environment. The system uses multiple units to enable an instructor to provide quality individual tutorial assistance. Many secondary school systems throughout the country have purchased the LINK Driver Trainer because it provides two important advantages: (1) it eliminates the possibility of accidents; and (2) it enables teaching a large number of students simultaneously, whereas only one student at a time can drive an automobile.

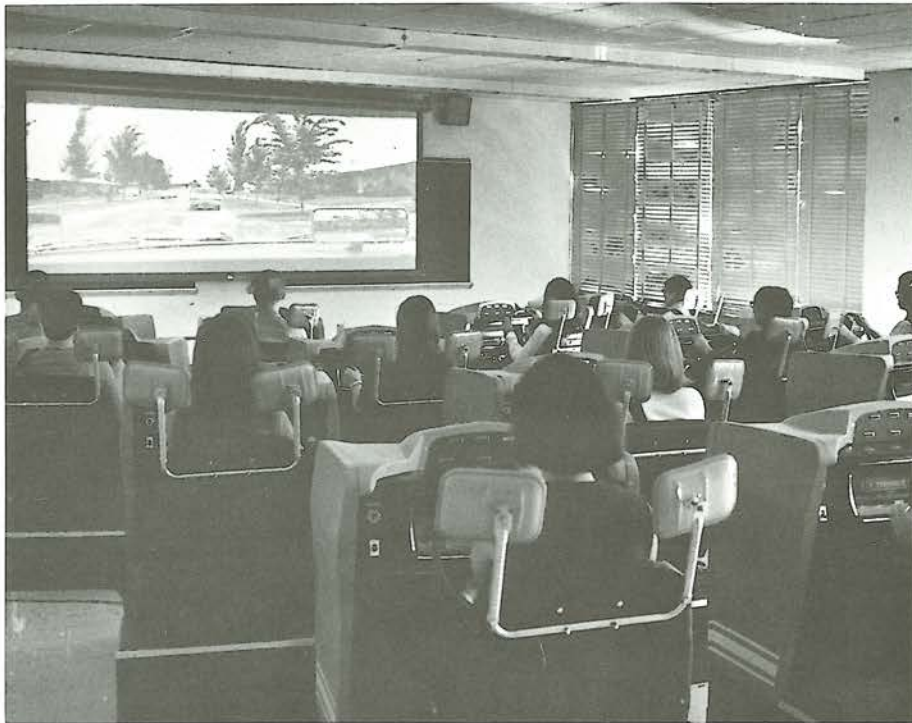

But the full scope of application of the Driving Simulator System has yet to be realized. For example, Iowa Central Community College under a federal grant made possible by the National Highway Safety Act recently placed an order for a classroom driver trainer for school bus drivers. An actual Blue Bird school bus is being outfitted to accommodate the Singer system. Other potential uses are also being reviewed.



# Closed Circuit Television Systems

Singer has become one of the industry leaders in producing effective Closed Circuit Television (CCTV) systems for industry. The basic elements of a CCTV system are the camera and the TV display. If desired, a remote control unit can be used for switching to allow viewing of a variety of points over the same systems.

## **Television Equipment**

**Singer has a complete product line of television systems and equipment.**

### **Cameras**

**GPL 470 Economy TV Camera**

**GPL 800 TV Camera**

**GPL 990 TV Camera**

**GPL 1000 TV Camera**

**GPL 1200 Viewfinder TV Camera**

**GPL-23 Low Light TV Camera**

### **TV Displays**

**Model PD-143F**

**14 inch TV Display and Cabinet**

**Model PD-143G**

**14 inch TV Display and Rack Mounting**

**Model PD-143H**

**14 inch TV Display**

## **MP-100 Studio Console**

The MP-100 Studio Console incorporates in one easily transportable cabinet all of the control and switching-fading functions normally required for professional production. Its compatibility with color programming and ability to intermix color and black and white video sources brings to the compact studio a professionalism usually associated with major broadcast production.

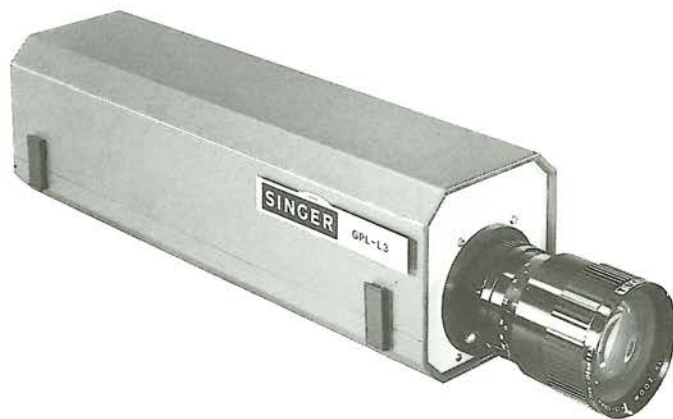
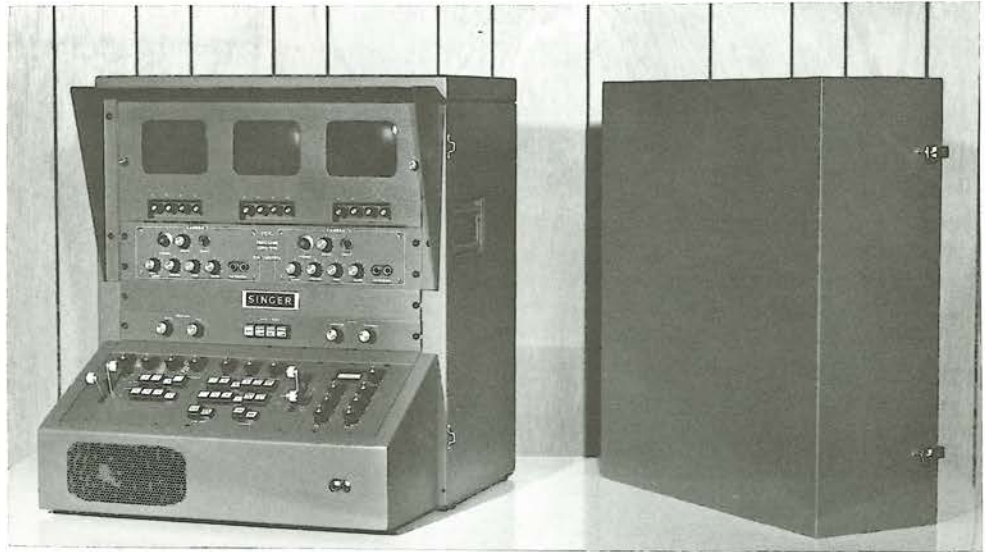

**Low Light Level TV Camera**

Closed Circuit Television Systems



***Economy TV Camera***

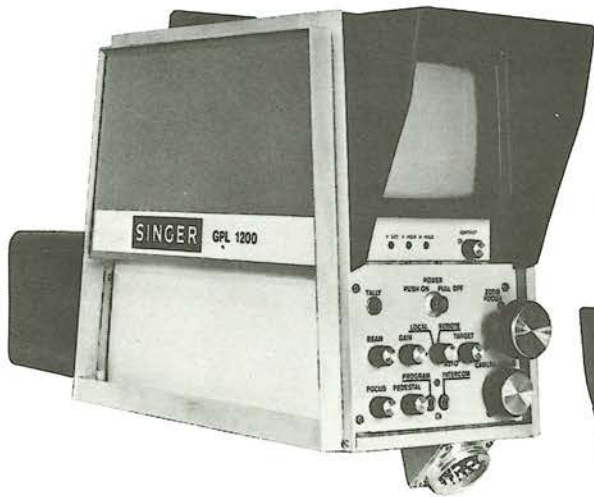

***Viewfinder TV Camera***

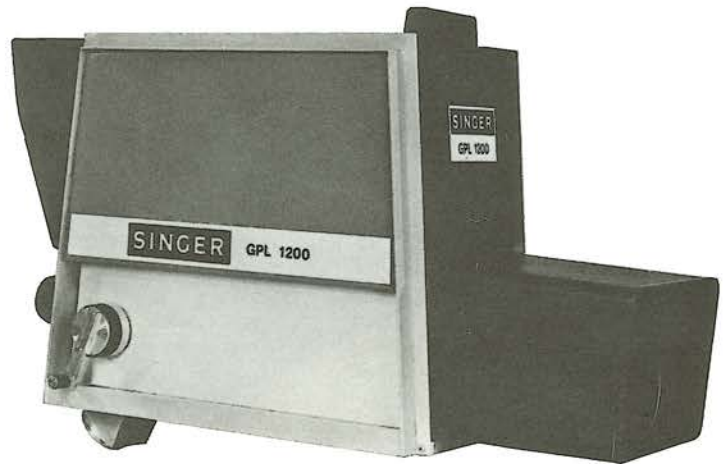

Closed Circuit Television Systems

# Traffic Control Systems

The Singer Simulation Products Division produces a full line of highly advanced signals and accessories that can be configured in a wide variety of traffic control systems, a number of which are presently installed in urban areas throughout the United States.

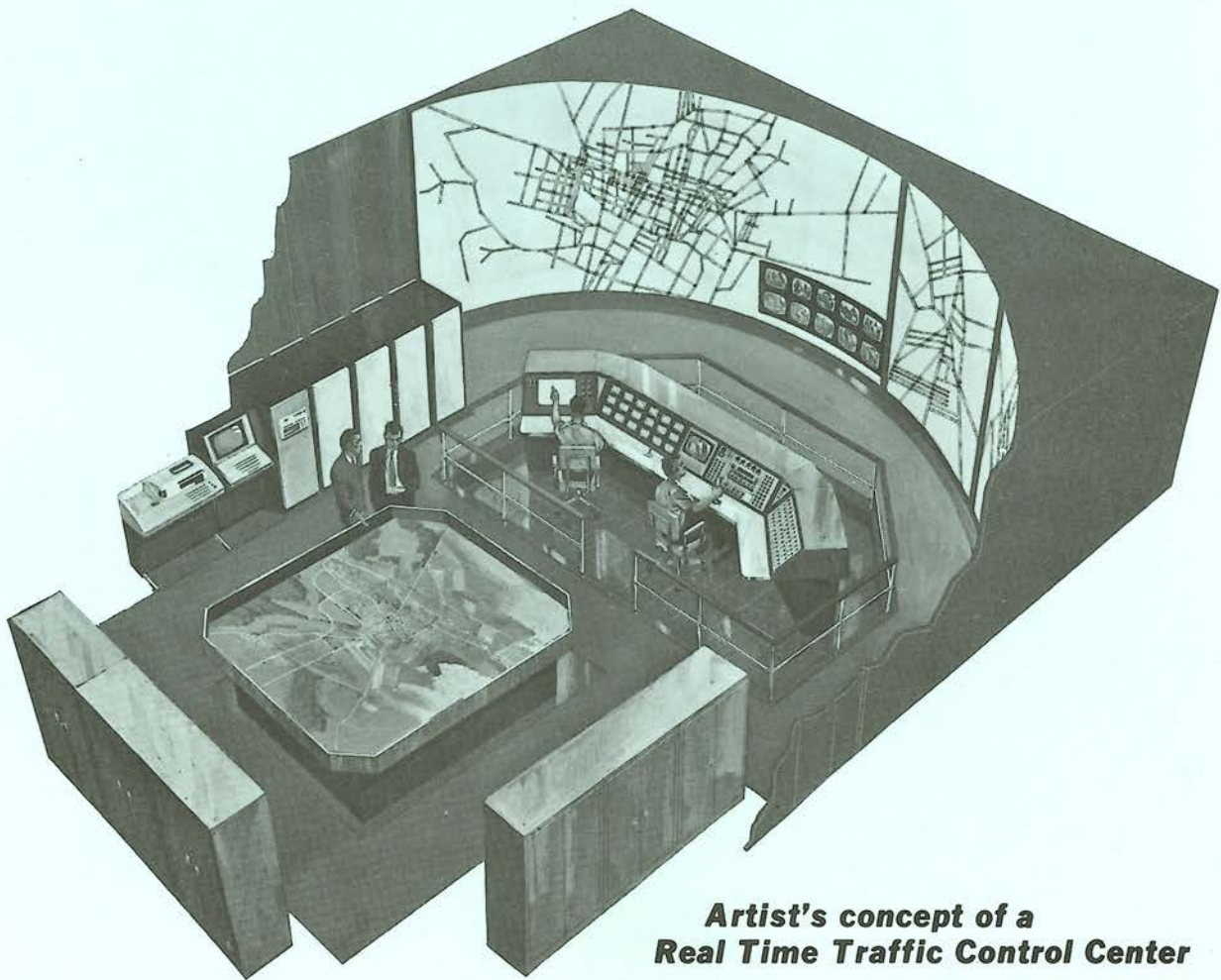

**Artist's concept of a  
Real Time Traffic Control Center**

**Traffic Control System  
Products**

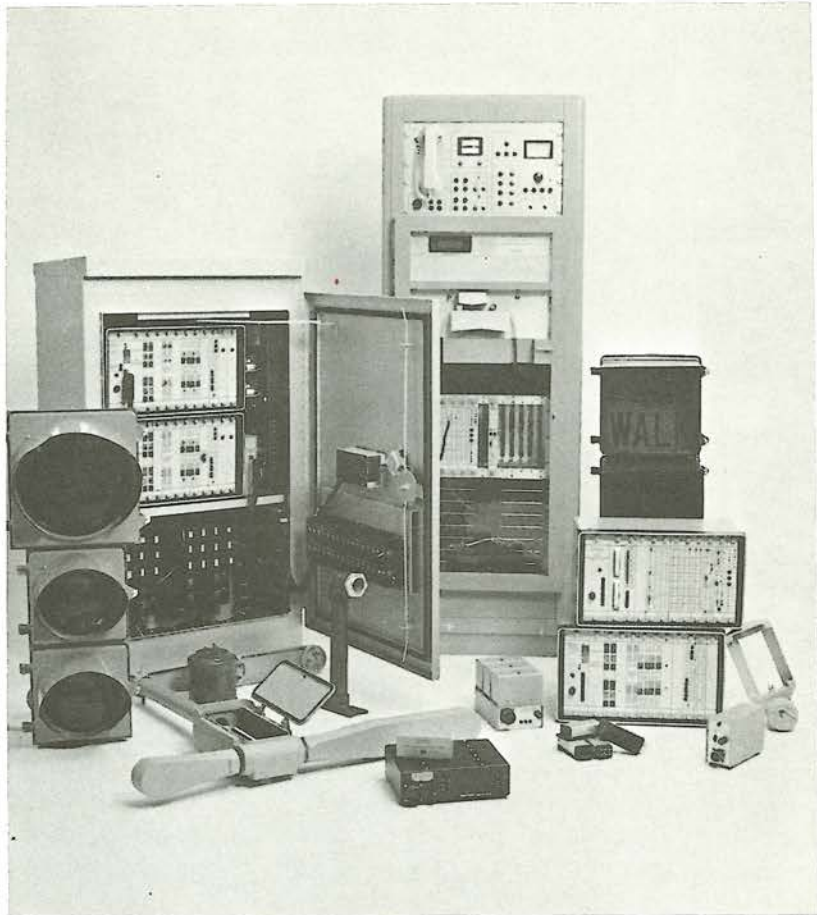

## **Automated Traffic Information System**

Singer Traffic Information Systems Operations has the following products on the market:

### Series 2000 Controller

The Series 2000 controller is used in traffic control applications ranging from two-phase, pre-timed to eight phase, quad left turn applications. The display module enables you to have a visual representation of intersection station.

### Series 3000 Master Controller

The Series 3000 Master Controller programming capabilities range from simple program selection based on time of day to calculations of detailed intersection programs in response to local traffic conditions.

Traffic Control Systems

# Customer Support

The Singer Simulation Products Division maintains one of the most capable and efficient customer support organizations in the world. Highly skilled field service engineers ensure that Singer equipment is properly installed at the customer's site and that the equipment is operating efficiently. Even after the system has been accepted and placed in operational service, Singer support continues and the customer is assured of reliable, prompt response to his needs throughout the lifetime of the training device. Two of the most important elements of Singer customer support are Field Services and Technical Training.





**.... a class in session at the Binghamton Technical Training Center**

## Field Service

With the present sophistication and complexity of flight simulators, weapon system trainers, space simulators, educational training devices, and special simulation-related products, increased emphasis is placed on expeditious service and complete support of Simulation Products Division devices. The prime objective of Field Service is to provide total support and assistance to all customers throughout the world during the operational life of the device so that maximum utilization may be realized. This objective is attained by providing liaison and direct assistance at the customer site, and training of customer personnel in operation and maintenance of the equipment. If desired by a customer, Singer will provide a staff of maintenance personnel in residence at the site to maintain the device for as long a period as requested.

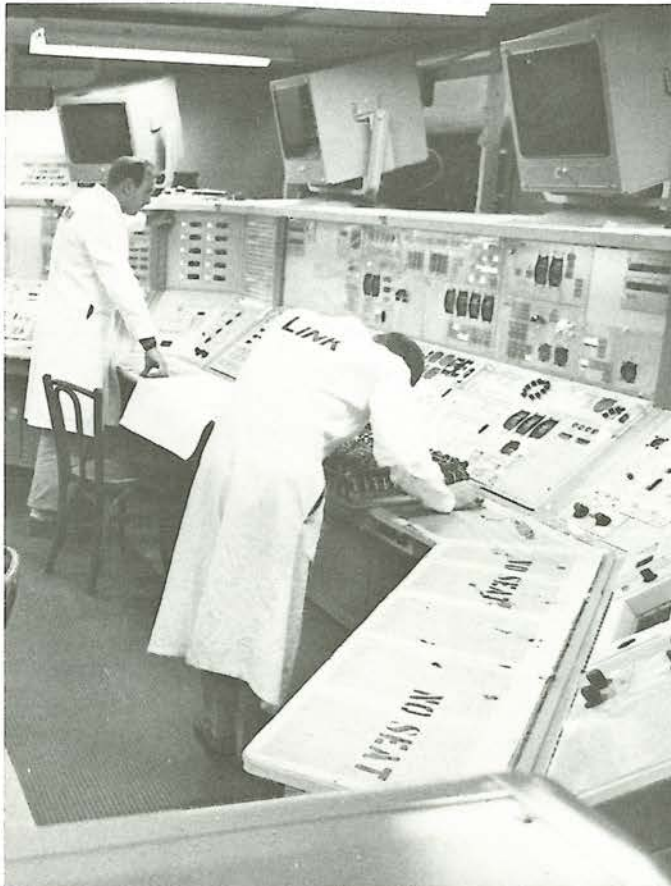

personnel attend Singer courses on simulation techniques and equipment, particularly on new and future-task-related subjects.

Currently, there are about a hundred field service technical representatives assigned to programs throughout the world providing such varied functions as:

- Follow-on and, in some cases, full maintenance and logistic support
- Equipment modification, update, and product improvement
- Classroom and on-the-job customer training on site

Singer field service personnel are knowledgeable and efficient because they conform to exacting standards of education and experience before they are permitted to accompany equipment into the field. Field engineers are required to have a BSEE degree or equivalent as well as 6 to 8 years of experience in maintenance and instruction on simulation equipment; field technicians must have an associate degree (AAS) or equivalent and 8 to 10 years of simulator-oriented experience. Prior to and between field assignments,

## **Technical Training**

While qualified field service personnel are always available to support a customer's simulator installation, Singer also takes pride in its facilities for training customer personnel in simulator operation and maintenance. The Singer Training Center is fully air conditioned and features a quiet, soft decor to provide all students with a proper learning environment. Individually decorated and soundproofed, each classroom contains closed circuit television plus all the necessary classroom equipment conducive to convenient, effective training. The Training Center is located in the Kirkwood Plant in Binghamton, New York, the same plant in which simulator final assembly and checkout occurs. Thus, it is possible for students to participate both in classroom and in hands-on equipment training when progress warrants.

All Singer technical instructors are fully qualified, simulation-knowledgeable specialists, who are selected with attention to the following criteria:

- Instructor training and experience
- Simulator experience, including electronics and computers
- Proven technical academic ability
- Total educational background

Training courses have been developed and are regularly scheduled, although new courses are developed and scheduled as technology dictates.



**SINGER**  
SIMULATION PRODUCTS